

AIR CONDITIONER

FUJITSU

## OPERATING MANUAL

Cassette type

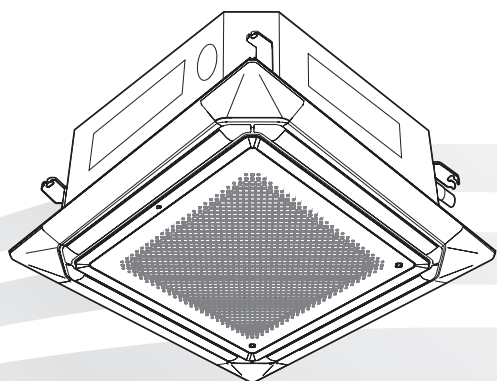

Indoor Unit

**AUTG30KRLA**

**AUTG36KRLA**

**AUTG45KRLA**

**AUTG54KRLA**

KEEP THIS MANUAL FOR FUTURE REFERENCE

FUJITSU GENERAL LIMITED

 <b>CAUTION</b>
<b>R32 REFRIGERANT</b>
<small>This Air Conditioner contains and operates with refrigerant R32.</small>
<b>THIS PRODUCT MUST ONLY BE INSTALLED OR SERVICED BY QUALIFIED PERSONNEL.</b>
<small>Refer to Commonwealth, State, Territory and local legislation, regulations, codes, installation &amp; operation manuals, before the installation, maintenance and/or service of this product.</small>



PART No. 9381622016-03

# OPERATING MANUAL

PART No. 9381622016-03  
Air Conditioner (Cassette type)

## CONTENTS

SAFETY PRECAUTIONS.....	1
NAME OF PARTS.....	2
FEATURES AND FUNCTIONS.....	2
CLEANING AND CARE.....	3
OPERATING TIPS.....	4
TEMPERATURE AND HUMIDITY RANGE.....	7
TROUBLESHOOTING.....	7
WARRANTY CARD.....	8

## SAFETY PRECAUTIONS

To prevent personal injury, or property damage, read this section carefully before you use this product, and be sure to comply with the following safety precautions. Incorrect operation due to failure to follow the instructions may cause harm or damage, the seriousness of which is classified as follows:





 **WARNING** This mark warns of death or serious injury.

 **CAUTION** This mark warns of injury or damage to property.

 This mark denotes an action that is PROHIBITED.

 This mark denotes an action that is COMPULSORY.

• Explanation of symbols displayed on the indoor unit or outdoor unit.

	<b>WARNING</b>	This symbol shows that this appliance uses a flammable refrigerant. If the refrigerant is leaked and exposure to an external ignition source, there is a risk of fire.
	<b>CAUTION</b>	This symbol shows that the Operating Manual should be read carefully.
	<b>CAUTION</b>	This symbol shows that a service personnel should be handling this equipment with reference to the Installation Manual.
	<b>CAUTION</b>	This symbol shows that information is available such as the Operating Manual or Installation Manual.

### **WARNING**

• The appliance shall be installed, operated and stored in a room with a floor area larger than X m<sup>2</sup>.

30 type	M (kg)	M ≤ 2.10	2.10 < M ≤ 2.50	2.50 < M ≤ 2.90
	X (m <sup>2</sup> )	4.20	5.96	8.02
36, 45 type	M (kg)	2.90 < M ≤ 3.30	3.30 < M ≤ 3.70	3.70 < M ≤ 3.90
	X (m <sup>2</sup> )	10.38	13.05	14.50
54 type	M (kg)	M ≤ 2.85	2.85 < M ≤ 3.25	3.25 < M ≤ 3.65
	X (m <sup>2</sup> )	7.74	10.07	12.70
	M (kg)	3.65 < M ≤ 4.05	4.05 < M ≤ 4.25	/
X (m <sup>2</sup> )	15.64	17.22		
54 type	M (kg)	M ≤ 3.10	3.10 < M ≤ 3.50	3.50 < M ≤ 3.90
	X (m <sup>2</sup> )	9.16	11.68	14.50
	M (kg)	3.90 < M ≤ 4.30	4.30 < M ≤ 4.50	/
X (m <sup>2</sup> )	17.63	19.31		

M (kg): Amount of refrigerant charge  
X (m<sup>2</sup>): Minimum room area

(IEC 60335-2-40)



- This product contains no user-serviceable parts. Always consult authorized service personnel for repairing, installation, and relocation of this product. Improper installation or handling will cause leakage, electric shock, or fire.
- In the event of a malfunction such as burning smell, immediately stop operation of the air conditioner, and disconnect all the power supply by turning off the electrical breaker or disconnecting the power plug. Then consult authorized service personnel.
- Take care not to damage the power supply cable. If the supply cord is damaged, it must be replaced by the manufacturer, its service agent or similarly qualified persons in order to avoid a hazard.
- In the event of refrigerant leakage, be sure to keep away from fire or any flammables, and consult authorized service personnel.
- In the event of a thunder storm or any prior sign of a lightning strike, turn off the air conditioner via the remote controller, and refrain from touching the product or the power source to prevent any electrical hazards.
- The appliance shall be stored in a room without continuously operating ignition sources (for example: open flames, an operating gas appliance or an operating electric heater).
- The appliance shall be stored in a well-ventilated area.
- Be aware that refrigerants may not contain an odour.
- The appliance shall be stored so as to prevent mechanical damage from occurring.
- Disposing of the product shall be done properly, in compliance with national or regional regulations.
- This appliance is not intended for use by persons (including children) with reduced physical, sensory or mental capabilities, or lack of experience and knowledge, unless they have been given supervision or instruction concerning use of the appliance by a person responsible for their safety. Children should be supervised to ensure that they do not play with the appliance.



- Do not start or stop the operation of this product by turning on or off the circuit breaker.
- Do not use inflammable gases near this product.
- Do not expose yourself directly to the cooling air flow for many hours.
- Do not insert your fingers or any other objects into outlet port or inlet port.
- Do not operate with wet hands.
- Do not install the unit in area filled with mineral oil such as a factory or area containing a large amount of splashed oil or steam such as a kitchen.
- Do not use means to accelerate the defrosting process or to clean the appliance, other than those recommended by the manufacturer.
- Do not pierce or burn.

## ⚠ CAUTION

- Provide occasional ventilation during use.
  - Always operate this product with air filters installed.
  - Ensure that any electronic equipment is at least 1 m away from this product.
  - Turn off power source when not using this product for extended periods.
  - After a long period of use, ensure to get the mounting of the indoor unit checked to prevent this product from falling down.
  - The air flow direction and the room temperature should be carefully considered when you use this product in a room with infants, children, elderly or sick persons.
  - Keep the surroundings of the outdoor unit clean and tidy, and do not place items around it. Any objects blocking or entering from the outlet ports may cause product malfunction.
- ⊘
- Do not direct the air flow at fireplaces or heating apparatus.
  - Do not block or cover the inlet port and the outlet port.
  - Do not apply any heavy pressure to radiator fins.
  - Do not climb on, place objects on, or hang objects from this product.
  - Do not place any other electrical products or household belongings under this product. Dripping condensation from this product might get them wet, and may cause damage or malfunction of your property.
  - Do not expose this product directly to water.
  - Do not use this product for preservation of food, plants, animals, precision equipment, art work, or other objects. This may cause quality deterioration of those items.
  - Do not expose animals or plants to the direct air flow.
  - Do not drink the drainage from the air conditioner.
  - Do not pull the power supply cable.
  - Do not touch the aluminium fins of heat exchanger built-in this product to avoid personal injury when you install or maintain the unit.
  - Do not stand on unstable steps when operating or cleaning this product. It may overturn and can cause injury.

## NAME OF PARTS

### Indoor unit

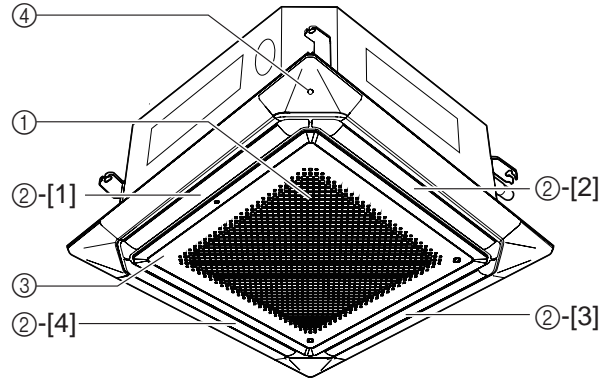

- ① Air filter (in air intake grille)
- ② Air flow direction outlet  
Individual air flow direction control: [1][2][3][4]
- ③ Air intake grille
- ④ Human sensor
- ⑤ Remote controller \*

\*: For detailed instructions on how to operate, please refer to the Operating manual of the remote controller.

## FEATURES AND FUNCTIONS

### INVERTER

On start-up, the air conditioner will operate at maximum capacity to bring the room quickly down to desired temperature. Once the temperature in the room begins to achieve the set temperature, the air conditioner will reduce its capacity and energy usage to the minimum capacity and input ratings.

### VERTICAL AIR FLOW

Comfortable air flow spread to every corner of the room by the wide vertical air flow.

### INDIVIDUAL AIR FLOW DIRECTION CONTROL

Each louver can be set individually using the wired remote controller to provide comfortable air flow.

### HUMAN SENSOR

The human sensor saves energy by catching the movement of people, operating either in a low capacity mode or stopping operation when people leave the room.

#### [Auto Saving]

When absent continues for the set time, the operation switches to energy saving operation.

#### [Auto Off]

When absent continues for the set time, indoor unit operation stops.

### ECONOMY OPERATION

When ECONOMY operation mode is operated, the room temperature will be little higher than the set-temp under cooling mode and lower than set-temp under heating mode. Therefore, the ECONOMY mode is able to save more energy than other normal mode.

## AUTO CHANGEOVER

The operation mode (cooling, heating) is switched automatically to maintain the set temperature, and the temperature is kept constant at all times.

## FAN CONTROL FOR ENERGY SAVING

When the set temperature is reached during cooling operation, the fan operates intermittently and power is saved.

## WEEKLY TIMER

Use this timer function to set operating times for each day of the week. Use the DAY OFF setting to switch off timed operation for a selected day in the coming week. Because all days can be set together, the weekly timer can be used to repeat the timer settings for all of the days.

## REMOVABLE INTAKE GRILLE

The indoor unit's intake grille can be removed for easy cleaning and maintenance.

## WIRED REMOTE CONTROLLER

The wired remote controller allows convenient control of indoor unit operation.

## WIRELESS REMOTE CONTROLLER (OPTION)

The optional wireless remote controller can be used. When you use the wireless remote controller, there are the following differences as compared with using the wired remote controller.

[ Additional functions for wireless remote controller ]

- SLEEP timer
- 10 °C HEAT operation

You can use both wireless and wired remote controller simultaneously, however, the functions will be restricted.

- 10 °C HEAT operation

# CLEANING AND CARE



## CAUTION



- Before cleaning the unit, be sure to stop the unit and disconnect the power supply.
- Turn off the electrical breaker.
- The fan operates at high speed inside the unit, and could result in personal injury.
- Be careful not to drop the intake grille.
- As filter cleaning involves high-altitude operation, please consult the professional technical service personnel.

- When used for extended periods, the unit may accumulate dirt inside, reducing its performance. We recommend that the unit be inspected regularly, in addition to your own cleaning and care. For more information, consult authorized service personnel.
- When cleaning the unit, do not use water hotter than 40°C, harsh abrasive cleansers, or volatile agents like benzene or thinner.
- Do not expose the unit to liquid insecticides or hairsprays.
- If the unit will not be operated for a period of 1 month or more, be sure to allow the inner parts of the unit to dry thoroughly, in advance, by operating the unit in Fan mode for half a day.

## Cleaning the air filter

- 1 Push the intake grille push buttons (two places) and open the intake grille.

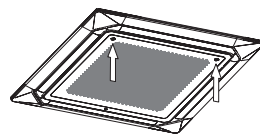

- 2 Pull out the filter from the intake grille.

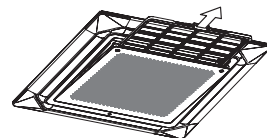

- 3 Clean the air filter.  
Remove the dust from the air filters by vacuuming or washing them. After washing, allow the air filters to dry thoroughly in an area protected from sunlight.
  - Dust can be cleaned from the air filter either with a vacuum cleaner, or by washing the filter in a solution of mild detergent and warm water. If you wash the filter, be sure to allow it to dry thoroughly in a shady place before reinstalling.
  - If dirt is allowed to accumulate on the air filter, air flow will be reduced, lowering operating efficiency and increasing noise.

- 4 Re-attach the air filters to the intake grille.

- ① Replace the air filter into its holder.
- ② Make sure that the air filter makes contact with the filter stopper when it is replaced into its holder.

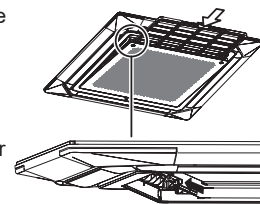

- 5 Close the intake grille.

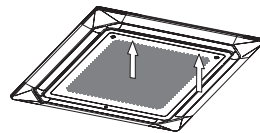

## NOTES

### Filter sign\*

Select appropriate intervals for displaying the filter sign on the indoor unit according to the estimated amount of dust in the air of the room.

Please consult authorized service personnel when using this function.

\*: For detailed instructions on how to operate, please refer to the Operating manual of the remote controller.

# OPERATING TIPS

Instructions relating to heating (\*) are applicable only to Heating and Cooling model (Reverse Cycle).

## Heating performance\*

- This air conditioner operates on the heat-pump principle, absorbing heat from outdoor air and transferring that heat indoors. As a result, the operating performance is reduced as outdoor air temperature drops. Also, please consult with your installation technician to ensure the unit is correctly sized for the room space required.
- Heat-pump air conditioners heat your entire room by recirculating air throughout the room, with the result that some time may be required after first starting the air conditioner until the room is heated.

## When indoor and outdoor temperatures are high\*

When both indoor and outdoor temperatures are high during use of the Heating mode, the outdoor unit's fan may stop at times.

## Microcomputer-controlled automatic defrosting\*

- When using the Heating mode under conditions of low outdoor temperature and high humidity, frost may form on the outdoor unit, reducing the operating performance. In order to prevent this reduced performance, this product is equipped with a microcomputer-controlled automatic defrosting function. During the defrost cycle, the indoor fan will shut down, and the defrost mode will be indicated. It will take maximum of 15 minutes before the air conditioner starts up again.
- After Heating operation stops, if frost forms on the outdoor unit, the unit will start Automatic defrosting operation. At this time, the outdoor unit will automatically stop after operating for a few minutes.

## Flow direction setting

### Vertical air direction adjustment

Airflow direction setting: ①, ②, ③, ④: During cooling/heating/dry mode

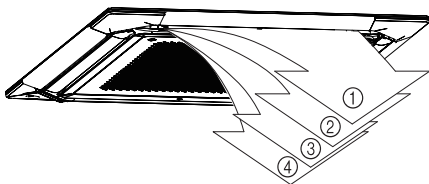

- The vertical airflow direction is set automatically as shown, in accordance with the type of operation selected.
  - During cooling/dry mode: Horizontal flow ②
  - During heating mode\*: Downward flow ④(30, 36 type) ③(45, 54 type)
- During AUTO mode operation, for the first minute after beginning operation, airflow will be horizontal ②; the air direction cannot be adjusted during this period. Even if the flow direction is set, it may operate at a different position at the start of heating operation, during defrost, or when AUTO(auto changeover) is selected.

## NOTES

- Attempting to move up/down air direction flaps manually could result in improper operation; in this case, stop operation and restart. The louvers should begin to operate properly again.
- When used in a room with infants, children, elderly or sick persons, the air direction and room temperature should be considered carefully when making settings.

### Horizontal air direction adjustment

The function cannot be used.

### Swing operation

The type of operation	Range of swing
Cooling/Heating/Dry/Fan	① to ④

The swing operation may stop temporarily when the air conditioner's fan is not operating, or when operating at very low speeds.

### Individual air flow direction control

When this function is used to set the louvers, it will be prioritized over other VT settings from other remote controllers or external devices. In order to change to other settings, disable the individual air flow direction control.

### Hot start\*

The indoor unit prevents cold drafts when Heating operation begins.

The indoor unit fan will not operate or it will operate at a very low speed until the heat exchanger reaches the set temperature.

### Low ambient cooling

When the outdoor temperature drops, the outdoor unit's fans may switch to low speed, or one of the fans may stop intermittently.

### Mode operation

#### Auto

##### Cooling model:

- When AUTO (auto changeover) operation first selected, the fan will operate at very low speed for about a few minutes, during which time the indoor unit detects the room conditions and selects the proper mode.
  - Room temperature is higher than the defined temperature in temperature setting → Cooling mode
  - Room temperature is close to or lower than the defined temperature in temperature setting → Monitor operation

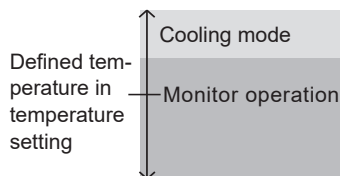

- When the indoor unit has adjusted your room's temperature to near the temperature setting, it will begin monitor operation. In the monitor operation mode, the fan will operate at low speed. If the room temperature subsequently changes, the indoor unit will once again select the appropriate operation (cooling) to adjust the temperature to the value set in the temperature setting.
- If the mode automatically selected by the unit is not what you wish, select one of the mode operation (COOL, DRY, FAN).

### Heating and Cooling model (Reverse cycle):

- When AUTO (auto changeover) is selected, the air conditioner selects the appropriate operation mode (cooling or heating) according to your room's present temperature.
- When Auto mode is first selected, the fan will operate at low speed for about a few minutes, during which time the indoor unit detects the room conditions and selects the proper operation mode.

Room temperature is higher than the defined temperature in temperature setting → Cooling mode

Room temperature is close to the defined temperature in temperature setting → Determined by outdoor temperature

Room temperature is lower than the defined temperature in temperature setting → Heating mode

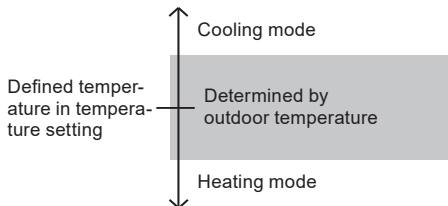

- When the air conditioner has adjusted your room's temperature to near the thermostat setting, it will begin monitor operation. In the monitor operation mode, the fan will operate at low speed. If the room temperature subsequently changes, the air conditioner will once again select the appropriate operation (Heating, Cooling) to adjust the temperature to the value set in the thermostat. If the mode automatically selected by the unit is not what you wish, select one of the mode operation (HEAT, COOL, DRY, FAN).

### Heat\*

- Use to warm your room.
- When Heating mode is selected, the air conditioner will operate at very low fan speed for about 3 to 5 minutes, after which it will switch to the selected fan setting. This period of time is provided to allow the indoor unit to warm up before beginning full operation.
- When the room temperature is very low, frost may form on the outdoor unit, and its performance may be reduced. In order to remove such frost, the unit will automatically enter the defrost cycle from time to time. During Automatic defrosting operation, the Heating operation will be interrupted.
- After the start of Heating operation, it takes sometime before the room gets warmer.

### Cool

Use to cool your room.

### Dry

- Use for gently cooling while dehumidifying your room.
- You cannot heat the room during Dry mode.
- During Dry mode, the unit will operate at low speed; in order to adjust room humidity, the indoor unit's fan may stop from time to time. Also, the fan may operate at very low speed when adjusting room humidity.
- The fan speed cannot be changed manually when Dry mode has been selected.

### Fan

Use to circulate the air throughout your room.

## **i** NOTES

### \*During Heating mode:

Set the thermostat to a temperature setting that is higher than the current room temperature. The Heating mode will not operate if the thermostat is set lower than the actual room temperature.

### During Cooling/Dry mode:

Set the thermostat to a temperature setting that is lower than the current room temperature. The Cooling and Dry modes will not operate if the thermostat is set higher than the actual room temperature (in Cooling mode, the fan alone will operate).

### During Fan mode:

You cannot use the unit to heat or cool your room.

### Human sensor (Auto saving/Auto off)

To prevent waste of electricity, this function controls the temperature setting when no one is occupying the room. Energy saving operation is on at the time of purchase.

### WARNING

Do not use this function when there are only infants, children, elderly or sick persons in the room.

### CAUTION

Do not use this function in server rooms or other places where there is no one in the room.

### About the Auto saving operation

If no one enters the room during the set time (15, 30, 60, 90, 120, 180 minutes), the set temperature will be automatically controlled.

(When someone comes back into the room, the human sensor will detect this, and automatically revert to the original settings.)

Operation mode	Operating details (if there is no one in the room for a while)
COOL/DRY	The set temperature will be increased by a maximum of approximately 2°C.
HEAT	The set temperature will be decreased by a maximum of approximately 2°C.
AUTO	This runs the Energy saving operation automatically for the selected mode (Cooling/ Heating/ Drying).

### About the Auto off operation

If no one enters the room during the set time (1 to 24 hours in 1 hour increments), the air conditioner will automatically stop operation.

## **i** NOTES

- This function cannot be used with group control.
- To restart operation, press the [On/Off] button.

## About the Human sensor

### Details about detection with the human sensor

The human sensor detects whether there are people in the room by looking for movement by people in the room.

Example of sensitivity range:

When the installation height gets higher, the temperature sensitivity decreases.



Do not place large objects near the human sensor. Also keep heating units outside the sensor's detection area.

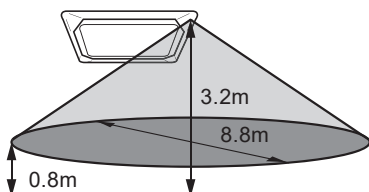

Equal sensitivity range of temperature

Ceiling height: 3.2 m

Detecting position: 0.8 m from floor surface

Auto saving operation may not work when the room temperature is very different from the temperature defined in temperature setting, such as when immediately after starting the operation.

### NOTES

Since the human sensor detects infrared light given out by people, there may be cases where this detection is incorrect.

#### Situations in which the sensor will detect no people in the room, even when there is someone there

- When the temperature is high and the difference with between people's body temperature is small. (Such as during the summer when the temperature is 30°C or higher)
- When there is someone in the room, but they do not move for a long period of time.
- When someone is hidden behind a sofa, other furniture, glass, or in similar situations.
- When someone is wearing extremely thick clothing and has their back facing the sensor.

#### Situations in which the sensor will incorrectly detect people in the room, even when there is no one there

- When there is a dog or a cat moving around in the room.
- When the wind is making curtains or plants move.
- When there are heating units, humidifiers, or electric appliances such as oscillating electric fans operating.

### Economy operation

At the maximum outlet, ECONOMY operation is approximately 70 % of normal air conditioner operation for cooling and heating.

If the room is not cooled (or heated), well during ECONOMY operation, select normal operation.

### Fan speed

Controls the fan speed.



When AUTO is selected, the fan speed is automatically adjusted according to the operation mode.

Heating\*: The fan will operate at very low speed when the temperature of the air issued from the indoor unit is low.

Cooling: As the room temperature approaches that of the set temperature, the fan speed becomes slower.

Fan: The fan runs at medium fan speed.

### Fan control for energy saving

- At Cooling or Dry mode, by using this function, the indoor unit fan will operate intermittently at a very low speed when the outdoor unit is stopped.
- When the fan setting is at Auto, this function will automatically be active to prevent humidity from returning to the room. To use this function in other fan modes, refer to the operation manual of the remote controller.

\*To use this function with other remote controllers, please consult an authorized service personnel.

### Auto restart

#### In Event of Power Interruption

- Should the power supply to the air conditioner be interrupted by a power failure, the air conditioner will restart automatically in the previously selected mode once the power is restored.
- Use of other electrical appliances (electric shaver, etc.) or nearby use of a wireless radio transmitter may cause the air conditioner to malfunction. In this event, temporarily disconnect the power supply, reconnect it, and then use the remote controller to resume operation.

### Multiple remote controller (optional)

An additional remote controller can be added up to the maximum of two remote controllers. Either remote controller can control the air conditioner. However, the timer functions cannot be used at the secondary unit.

### Group control

One remote controller can control up to 16 air conditioners. All of the air conditioners will be operated with the same settings.

### Demand Response and Indoor Unit Operation

This product is designed to be compatible with Air Conditioning Demand Response program.

To utilize the function, you need a separate arrangement with your electricity supplier. Please check availability in the place of use.

When your electricity supplier activates one of the following 3 Demand Response (DR) modes, the air conditioner switches over to the appropriate operation. If the optional IR receiver is installed, operation indicators will inform you when the unit has entered the DR mode.

#### OPERATION indicator



Blinking pattern and the intervals are as follows

- AUTO/COOL/HEAT/DRY/FAN operations

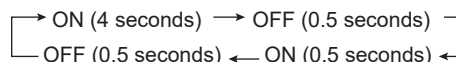

- 10°C HEAT operation

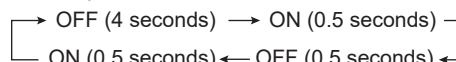

The indicator will keep blinking until the unit finishes the function.

DR mode	Description of operation in this mode
DR mode 1	Compressor off.
DR mode 2	The air conditioner continues to cool or heat during the Demand Response event, but the electrical energy consumed by the air conditioner in a half hour period is not more than 50% of the total electrical energy that would be consumed if operating at the rated capacity in a half hour period.
DR mode 3	The air conditioner continues to cool or heat during the Demand Response event, but the electrical energy consumed by the air conditioner in a half hour period is not more than 75% of the total electrical energy that would be consumed if operating at the rated capacity in a half hour period.

When the unit enters the DR mode, it performs moderate operation so the cooling or heating effect may be reduced. You cannot override this operation by changing the temperature setting using the remote controller or other actions unless the unit finishes the operation. When the unit finishes the operation, it will perform the operation that was previously performed before entering the DR mode.

### **i** NOTES

Stopping the operation of the air conditioner by using the remote controller or by OFF timer are valid in DR mode. If the timer operation is interfered by an interruption of power supply such as a blackout and the power supply is resumed, no indication of the DR mode is performed.

If you have operational issues, contact your electricity supplier first to check whether they are activating any of the DR mode described above.

If the air conditioner is under demand controlling, consult the issues with your electricity supplier.

If they are not demand controlling the air conditioner, refer to your warranty card for the contact details of Fujitsu General (AUST.) PTY LIMITED or visit our website :

[www.fujitsugeneral.com.au](http://www.fujitsugeneral.com.au)

### Notices

- \* During use of the Heating mode, the outdoor unit will occasionally commence the defrost operation for brief periods. During the defrosting operation, if the user sets the indoor unit for heating again, the defrosting mode will continue, and the Heating operation will begin after completion of defrosting, with the result that some time may be required before warm air is emitted.
- \* During use of the Heating mode, the top of the indoor unit may become warm, but this is due to the fact that coolant is circulated through the indoor unit even when it is stopped; it is not a malfunction.

## TEMPERATURE AND HUMIDITY RANGE

For the permissible ranges of temperature and humidity, refer to the installation manual.

## TROUBLESHOOTING

Instructions relating to heating (\*) are applicable only to Heating and Cooling model (Reverse Cycle).

### WARNING

-  In the event of a malfunction (burning smell, etc.), immediately stop operation, turn off the electrical breaker, and consult authorized service personnel. Merely turning off the unit's power switch will not completely disconnect the unit from the power source. Always be sure to turn off the electrical breaker to ensure that power is completely off.

Before requesting service, perform the following checks:

### NORMAL FUNCTION

#### Does not operate immediately

- If the unit is stopped and then immediately started again, the compressor will not operate for about 3 minutes, in order to prevent fuse blowouts.
- Whenever the electrical breaker is turned off then on again, the protection circuit will operate for about 3 minutes, preventing unit operation during that period.

#### Noise is heard

- During operation and immediately after stopping the unit, the sound of water flowing in the air conditioner's piping may be heard. Also, noise may be particularly noticeable for about 2 to 3 minutes after starting operation (sound of coolant flowing).
- During operation, a slight squeaking sound may be heard. This is the result of minute expansion and contraction of the front cover due to temperature changes.
- \* During Heating operation, a sizzling sound may be heard occasionally. This sound is produced by the Automatic defrosting operation.

#### Smells

- Some smell may be emitted from the indoor unit. This smell is the result of room smells (furniture, tobacco, etc.) which have been taken into the air conditioner.

#### Mist or steam are emitted

- During Cooling or Dry operation, a thin mist may be seen emitted from the indoor unit. This results from the sudden cooling of room air by the air emitted from the air conditioner, resulting in condensation and misting.
- \* During Heating operation, the outdoor unit's fan may stop, and steam may be seen rising from the unit. This is due to the Automatic defrosting operation.

#### Air flow is weak or stops

- Indoor unit fan may start later than the outdoor unit fan, or it may stop when the outdoor unit fan is not operating. This is due to the Fan control for energy saving operation.
- To disable this function, refer to the operation manual of the remote controller. (This function cannot be disabled in Auto fan mode.)
- \* When Heating operation is started, fan speed is temporarily very low, to allow internal parts to warm up.
- \* During Heating operation, if the room temperature rises above the thermostat setting, the outdoor unit will stop, and the indoor unit will operate at very low fan speed. If you wish to warm the room further, set the thermostat to a higher setting.
- \* During Heating operation, the unit will temporarily stop operation (maximum of 15 minutes) as the Automatic defrosting mode operates. During the Automatic defrosting operation, the defrost mode will be indicated.

<<See operating manual of Remote controller.>>



<ul style="list-style-type: none"> <li>• The fan may operate at very low speed during Dry operation or when the unit is monitoring the room's temperature.</li> </ul>
<ul style="list-style-type: none"> <li>• During Quiet operation, the fan will operate at very low speed.</li> </ul>
<ul style="list-style-type: none"> <li>• In the monitor Auto operation, the fan will operate at very low speed.</li> </ul>
<b>The Auto off operation does not operate even if there is no one in the room</b>
<ul style="list-style-type: none"> <li>• The sensor may incorrectly detect people even if there is no one in the room.</li> </ul>
<b>The flow direction does not change according to the setting or does not change at all</b>
<ul style="list-style-type: none"> <li>• Even if the flow direction is set, it may operate temporarily at a different position at the start of heating operation, during defrost, or when AUTO (auto changeover) is selected.</li> <li>• The individual VT Hold may be set.            &lt;&lt;See operating manual of Remote controller.&gt;&gt;</li> </ul>
<b>Water is produced from the outdoor unit</b>
<ul style="list-style-type: none"> <li>* During Heating operation, water may be produced from the outdoor unit due to the Automatic defrosting operation.</li> </ul>
<b>Humidity does not drop</b>
<p>In the case of Dry operation.</p> <ul style="list-style-type: none"> <li>• In some conditions of the room, the humidity does not drop.</li> <li>• In order to lower the humidity, set a lower room temperature.</li> </ul>

**CHECK ONCE MORE**

<b>Does not operate at all</b>
<ul style="list-style-type: none"> <li>• Has the circuit breaker been turned off?</li> <li>• Has there been a power failure?</li> <li>• Has a fuse blown out, or a circuit breaker been tripped?</li> <li>• Is the timer operating?</li> <li>• Is the Auto off operation of the Human sensor setting active?</li> </ul>
<b>Poor cooling (or heating*) performance</b>
<ul style="list-style-type: none"> <li>• Is the air filter dirty?</li> <li>• Are the air conditioner's intake grille or outlet port blocked?</li> <li>• Did you adjust the room temperature settings (thermostat) correctly?</li> <li>• Is there a window or door open?</li> <li>• In the case of Cooling operation, is a window allowing bright sunlight to enter? (Close the curtains.)</li> </ul>
<ul style="list-style-type: none"> <li>• In the case of Cooling operation, are there heating apparatus and computers inside the room, or are there too many people in the room?</li> <li>• Is the unit set for Quiet operation?</li> <li>• Is the Auto saving operation of the Human sensor setting active?</li> <li>• Is the air conditioner in Economy mode?</li> <li>• Is the unit controlled by the Demand response operation?</li> </ul>

If the problem persists after performing these checks, or if you notice burning smells, stop operation immediately, disconnect the power supply, and consult with authorized service personnel.

## WARRANTY CARD

Warranty card is available in the outdoor unit or by download at [www.fujitsugeneral.com.au](http://www.fujitsugeneral.com.au).





**FUJITSU**

**FUJITSU GENERAL LIMITED**

3-3-17, Suenaga, Takatsu-ku, Kawasaki 213-8502, Japan