

OPERATION MANUAL

AIR CONDITIONER (Wall-Mounted type)

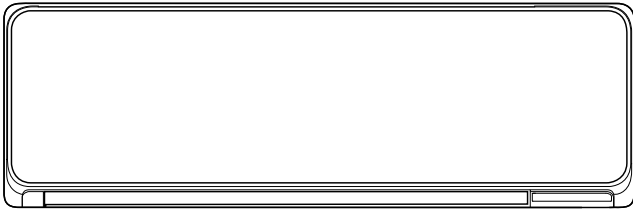

MODEL: □ ASTH18CNTA

* Check the model name.
(Refer to the rating label.)

Before using this product, read these instructions thoroughly and keep this manual for future reference.



Contents

1. SAFETY PRECAUTIONS.....	1
2. PREPARATION.....	2
2.1. Inserting batteries.....	3
3. NAME OF PARTS.....	3
3.1. Indoor unit.....	3
3.2. Remote controller.....	3
4. BASIC OPERATIONS.....	5
5. AIRFLOW SETTINGS.....	5
5.1. Fan speed setting.....	5
5.2. Airflow direction setting.....	5
6. TIMER OPERATIONS.....	5
6.1. On timer or Off timer.....	6
6.2. Program timer.....	6
6.3. Sleep timer.....	6
7. ENERGY SAVING OPERATIONS.....	6
7.1. Economy operation.....	6
7.2. Fan control for energy saving.....	6
7.3. Demand Response.....	6
8. OTHER OPERATION.....	7
8.1. Powerful operation.....	7
9. SETTINGS ON INSTALLATION.....	7
9.1. Remote controller custom code setting.....	7
10. CLEANING AND CARE.....	7
11. GENERAL INFORMATION.....	9
12. OPTIONAL PARTS.....	9
12.1. Wired remote controller.....	9
13. TROUBLESHOOTING.....	9

1. SAFETY PRECAUTIONS

To prevent personal injury or property damage, read this section carefully before you use this product, and be sure to comply with the following safety precautions.

Incorrect operation due to failure to follow the instructions may cause harm or damage, the seriousness of which is classified as follows:

WARNING

This mark warns of death or serious injury.

CAUTION

This mark warns of injury or damage to property.



This mark denotes an action that is PROHIBITED.



This mark denotes an action that is COMPULSORY.

Explanation of symbols displayed on the indoor unit or outdoor unit.



WARNING

This symbol shows that this product uses a low burning velocity material. If the refrigerant is leaked and exposed to an external ignition source, there is a risk of fire.



CAUTION

This symbol shows that the operation manual should be read carefully.



CAUTION

This symbol shows that a service personnel should be handling this equipment with reference to the installation manual.



CAUTION

This symbol shows that information is available such as the operation manual or installation manual.

WARNING



- When installing this product to an unventilated area, pay attention to prevent fire and explosion caused by the stagnated gas in case of refrigerant leakage. (For products which contain more than 1.842 kg refrigerant.)
- This product contains no user-serviceable parts. Always consult authorized service personnel for repairing, installation, and relocation of this product. Improper installation or handling will cause leakage, electric shock, or fire.
- In the event of a malfunction such as burning smell, immediately stop operation of the air conditioner, and disconnect all the power supply by turning off the electrical breaker or disconnecting the power plug. Then consult authorized service personnel.
- Take care not to damage the power supply cable. If it is damaged, it should be replaced only by authorized service personnel in order to avoid a hazard.
- If a refrigerant leakage is suspected, all naked flames shall be removed or extinguished, and consult authorized service personnel.
- In the event of a thunder storm or any prior sign of a lightning strike, turn off the air conditioner via the remote controller, and refrain from touching the product or the power source to prevent any electrical hazards.



! WARNING

- ! This product shall be stored in a room without continuously operating ignition sources (for example: open flames, an operating gas appliance or an operating electric heater).
 - This product shall be stored in a well-ventilated area.
 - Be aware that refrigerants may not contain an odour.
 - This product shall be stored so as to prevent mechanical damage from occurring.
 - Disposing of the product shall be done properly, in compliance with national or regional regulations.
 - During transportation or relocation of the indoor unit, pipes shall be covered with the wall hook bracket for protection.
Do not move this product by holding the indoor unit pipes. (The stress applied to the pipe joints may cause the flammable gas to leak during operation).
 - This product is not intended for use by persons (including children) with reduced physical, sensory or mental capabilities, or lack of experience and knowledge, unless they have been given supervision or instruction concerning use of this product by a person responsible for their safety. Children should be supervised to ensure that they do not play with this product.
 - Dispose of the packing materials safely. Tear and dispose of the plastic packing bags so that children cannot play with them. There is danger of suffocation if children play with the original plastic bags.
- ⊘ Do not start or stop the operation of this product by inserting or pulling out the power plug, or by turning on or off the circuit breaker.
 - Do not use flammable gases near this product.
 - Do not expose yourself directly to the cooling airflow for many hours.
 - Do not insert your fingers or any other objects into the outlet port or intake grille.
 - Do not operate with wet hands.
 - Do not pierce or burn.

! CAUTION

- ! Provide occasional ventilation during use.
 - Before cleaning this product, be sure to turn it off and disconnect all the power supply.
 - Always operate this product with air filters installed.
 - Ensure that any electronic equipment is at least 1 m (40 in) away from this product.
 - Disconnect all the power supply when not using this product for extended periods.
 - After a long period of use, ensure to get the mounting of the indoor unit checked to prevent this product from falling down.
 - The airflow direction and the room temperature should be carefully considered when you use this product in a room with infants, children, elderly or sick persons.
 - Keep the surroundings of the outdoor unit clean and tidy, and do not place items around it. Any objects blocking or entering from the outlet ports may cause product malfunction.
- ⊘ Do not direct the airflow at fireplaces or heating apparatus.
 - Do not block or cover the intake grille and the outlet port.
 - Do not apply any heavy pressure to radiator fins.
 - Do not climb on, place objects on, or hang objects from this product.
 - Do not place any other electrical products or household belongings under this product. Dripping condensation from this product might get them wet, and may cause damage or malfunction of your property.

! CAUTION

- ⊘ Do not expose this product directly to water.
- Do not use this product for preservation of food, plants, animals, precision equipment, art work, or other objects. This may cause quality deterioration of those items.
- Do not expose animals or plants to the direct airflow.
- Do not drink the drainage from the air conditioner.
- Do not pull the power supply cable.
- Do not touch the aluminum fins of heat exchanger built-in this product to avoid personal injury when you maintain the unit.
- Do not stand on unstable steps when operating or cleaning this product. It may overturn and can cause injury.

This product contains fluorinated greenhouse gases.

2. PREPARATION

! WARNING

- ! Take care to prevent infants and young children from accidentally swallowing the batteries.

! CAUTION

- ! If leaking battery fluid comes in contact with your skin, eyes, or mouth, immediately rinse with plenty of clean water, and consult your physician.
 - Exhausted batteries must be removed immediately, and be disposed according to the local laws and regulations of your region.
- ⊘ Do not attempt to recharge dry batteries.
 - Do not use dry batteries that has been recharged.

Indoor unit accessories

Check that the following accessories are included.

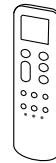

Remote controller



Remote controller holder



Self-tapping screws

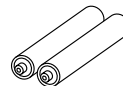

Batteries

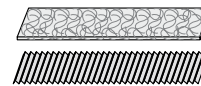

Air cleaning filters



Air cleaning filter holders

How to use the remote controller holder

1

Self-tapping screws

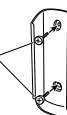

2

Insert



3

Slide up

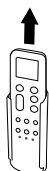

2.1. Inserting batteries

Battery type: R03/LR03/AAA × 2

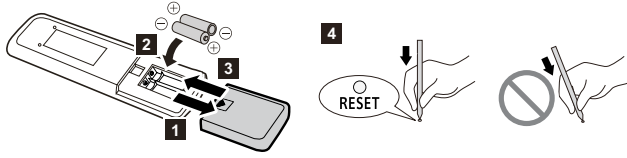

1~3. Put batteries as shown in the figure above.

4. Press **RESET** as shown in the figure above.

NOTES:

- Use specified type of batteries only.
- Do not mix different types or new and used batteries together.
- Batteries can be used about 1 year in ordinary use.
- If the remote control range noticeably shortens, replace the batteries, and press **RESET** as shown in the figure above.

3. NAME OF PARTS

CAUTION

For appropriate signal transmission between the remote controller and the indoor unit, keep the signal receiver away from the following items:

- Direct sunlight or other strong lights
- Flat-panel television screen

In rooms with instantaneous fluorescent lights, such as inverter type ones, the signal may not be transmitted properly. In such a case, consult the store of purchase.

3.1. Indoor unit

For Manual Auto operation and Filter indicator reset
(Refer to page 10.)

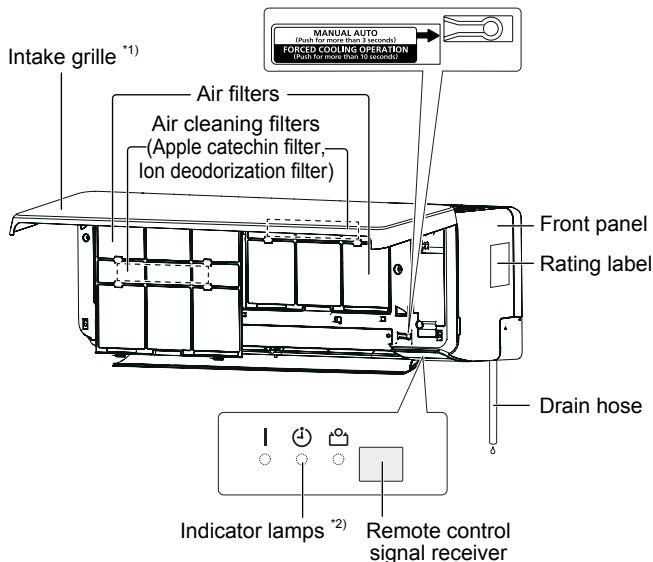

*1) Before starting operation, make sure that the intake grille is closed completely. Incomplete closing may affect the proper function or performance of the product.

*2) Indicator lamps light in the following conditions.

	Name	Color	Operation or condition
	Operation	Green	Normal operation
🕒	Timer	Orange	Timer operation
🏠	Economy	Green	Economy operation

3.2. Remote controller

CAUTION

- To prevent malfunction or damage of the remote controller:
 - Place remote controller at where will not be exposed to direct sunlight or excessive heat.
 - Remove batteries if the product is not going to be used for an extended period.
 - Obstacles such as a curtain or wall between the remote controller and the indoor unit may affect the appropriate signal transmission.
- Do not apply strong shocks to the remote controller.
- Do not pour water on the remote controller.

When you use the optional remote controller, the appearance and the operation procedure may differ.
For details, refer to the operation manual of each remote controller.

- * : The setting must be done while the setting screen is displayed for each function.
- | : The button is controllable only when the air conditioner is operating.

Signal transmitter

Aim at the signal receiver of the indoor unit properly.

- Operating range is approximately 7 m.
- [▲] will appear when the signal is transmitted.
- The indoor unit will emit a beep when it receives the signal properly. If there is no beep, press the button again.

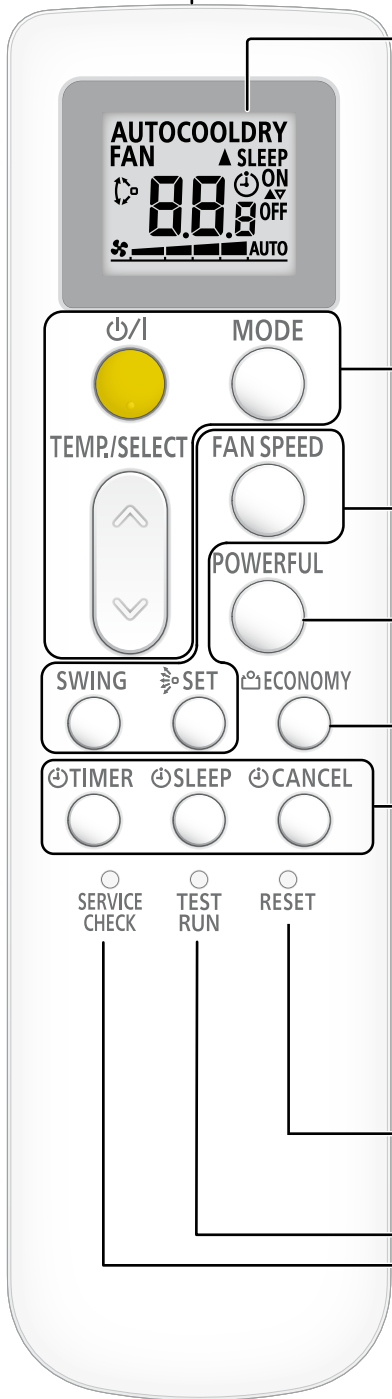

Remote controller display

In this section, all the possible indicators are displayed for description. In actual operation, the display is linked with the button operation, and only shows the necessary indicators for each setting.

For Basic operations Refer to page 5.

	Starts or stops the air conditioner operation.	
	Changes the operation mode.	*
	Adjusts the setting temperature./ Adjusts the value of the timer settings.	*

For Airflow settings Refer to page 5.

	Controls the fan speed.	*
	Sets the automatic Swing operation.	*
	Controls the up/down airflow direction.	

For Powerful operation Refer to page 7.

	Activates or deactivates the Powerful operation.	
--	--	--

For Energy saving operation Refer to page 6.

	Activates or deactivates the Economy operation.	
--	---	--

For Timer operations Refer to page 5.

	Starts the timer setting.	*
	Activates the Sleep timer.	*
	Deactivates the timer setting.	

After replacing batteries Refer to page 3.

	Resets the settings of the remote controller.	
--	---	--

Do not press this button in normal use.
It starts the test run (for use by authorized service personnel only).
NOTE: If the test run starts unintentionally, press to quit the test run.

Do not press this button in normal use.
If there seems to be a problem, check the error code. (Refer to page 10)

How to press the button inside the hole

Press this button as shown in the following figure. Use the tip of a ballpoint pen or other small object.



4. BASIC OPERATIONS

3 steps to start operation

1. Press \odot /I to start or stop the operation.

2. Press MODE to select the operation mode.

The operation mode changes as follows.

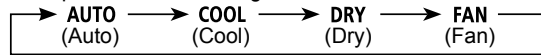

3. Press TEMP/SELECT (\heartsuit / \heartsuit) to set the desired temperature.

The temperature changes by 0.5°C increments.

Temperature setting range	
Auto/Cooling/Dry	18.0-30.0°C

NOTES:

- In the Cooling or Dry mode, set the temperature lower than the current room temperature.
- In the Fan mode, temperature control is not available.

5. AIRFLOW SETTINGS

5.1. Fan speed setting

Press FAN SPEED to control the fan speed.

The fan speed changes as follows.

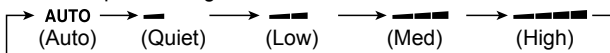

When **AUTO** is selected, the fan speed depends on the operating condition.

NOTE: In the Dry mode, the fan speed is fixed to **AUTO**.

5.2. Airflow direction setting

For details of the airflow ranges, refer to "Airflow direction range".

Up/down airflow direction setting

Press \Rightarrow SET to adjust the Up/down airflow direction.

Left/right airflow direction setting



CAUTION

- Before you adjust the left/right airflow direction, make sure that the horizontal louver has been stopped completely.

Adjust two knobs of the vertical louvers by hand.

Swing operation setting

Press SWING to start/stop the Swing operation.

NOTE: The Swing operation may stop temporarily when the indoor unit fan is rotating at very low speed or is stopped.

Airflow direction range

Up/down airflow direction

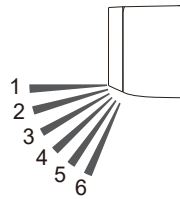

Change by \Rightarrow SET	
Cooling, Dry	1 \rightleftarrows 2 \rightleftarrows 3 (\rightleftarrows 4 \rightleftarrows 5 \rightleftarrows 6)
Fan	1 \rightleftarrows 2 \rightleftarrows 3 \rightleftarrows 4 \rightleftarrows 5 \rightleftarrows 6
Swing operation by SWING	
Cooling, Dry	1 \longleftrightarrow 4
Fan *	1 \longleftrightarrow 4 or 3 \longleftrightarrow 6

* The Swing operation range depends on the airflow direction set before the Swing operation.

NOTES:

- Do not adjust the horizontal louvers by hand.
- In the Auto mode, the airflow direction stay position 1 for a while from the start of the operation.
- In the Cooling or Dry mode, the downward airflow can change to the upper as follows. This feature is to prevent condensation from dripping and damaging your property.

Condition: Position 4-6 keeps for 30 minutes
Airflow adjusted to: Position 3

6. TIMER OPERATIONS

NOTE: When [\odot] indicator on the indoor unit blinks, set the clock and timer again. This blinking shows that the internal clock goes wrong due to an interruption of the power supply.

Timer setting procedure

1. Press \odot TIMER to choose timer operation.

Each time you press the button, the timer operation will change as follows:

	Off timer	Stops the operation at your desired time.
	On timer	Starts the operation at your desired time.
	Program timer	Operates as the combination of the On timer and Off timer.

- To cancel the timer setting during the procedure, press \odot CANCEL.
 - To set sleep timer, press \odot SLEEP. (Refer to "6.3. Sleep timer".)
2. Set each timer operation.
For details, refer to the following instructions of each timer setting.

6.1. On timer or Off timer

1. Select On timer or Off timer in step 1 of "Timer setting procedure."
2. Each time you press TEMP/SELECT (↖↗), the time changes as follows:

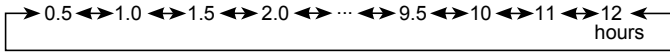

- When you use the On timer, set the time while the **ON** indicator on the remote controller display is blinking.
- When you use the Off timer, set the time while the **OFF** indicator on the remote controller display is blinking.
- To deactivate the On/Off timer, press **CANCEL** while [**ON**] or [**OFF**] is shown on the remote controller display. The indicator will disappear.

NOTE: If you set the Sleep timer after setting the On/Off timer, the On/Off timer is canceled.

6.2. Program timer

1. Set On timer and Off timer. (Refer to "6.1. On timer or Off timer".)
2. Select Program timer in step 1 of "Timer setting procedure".

After the time set by the earlier timer passed, the timer set later will begin the counting down.

The order of the timer operation is displayed as follows:

Timer	Indicator on the remote controller display
Off→On timer	ON ▲ OFF
On→Off timer	ON ▼ OFF

NOTE: If you set the Sleep timer after setting the Program timer, the Program timer is canceled.

6.3. Sleep timer

The Sleep timer supports your comfortable sleep by moderating the air conditioner operation gradually.

Press **SLEEP**.

Each time you press the button, the time changes as follows:

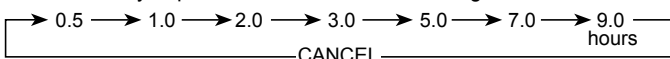

To repeat the timer, press the button when **SLEEP** indicator is not displayed.

During the Sleep timer operation, the setting temperature changes as the following figure.

In Cooling or Dry mode

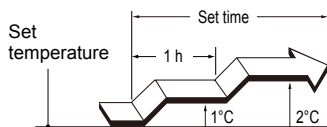

After the set time has elapsed, the air conditioner operation turns off.

7. ENERGY SAVING OPERATIONS

7.1. Economy operation

It saves more electricity than other operation modes by changing the set temperature to a moderate setting.

Press **ECONOMY** to activate/deactivate the Economy operation.

[**ECONOMY**] indicator on the indoor unit will turn on.

Operation mode	Room temperature
Cooling/Dry	Few degrees higher than the set temperature

NOTES:

- In the Cooling or Dry mode, the maximum output of this operation is approximately 70% of usual operation.
- This operation cannot be performed during the temperature monitoring by the Auto mode.

7.2. Fan control for energy saving

In the Cooling operation, when the room temperature reaches the set temperature, the indoor unit fan rotates intermittently to save the power. (This function is deactivated at the time of purchase.)



To change the setting, use the following steps;

1. Press **ON/OFF** until the indicators on the remote controller turn off.
2. Press and hold **FAN SPEED** for more than 5 seconds.
The **FC** and the current status will appear.
ON : Activated
OFF : Deactivated
3. Press TEMP/SELECT (↖↗) to switch the status.
4. Press **ON/OFF** to send the setting to the indoor unit.
The display will return to the original screen.

NOTE: If you do not press any buttons for 30 seconds after **FC** is displayed, **FC** will turn off. In this case, repeat the setting from step 2.

7.3. Demand Response

This product is designed to be compatible with Air Conditioning Demand Response program.

To utilize the function, you need a separate arrangement with your electricity supplier. Check availability in the place of use.

When your electricity supplier activates one of the following 3 Demand Response (DR) modes, the air conditioner switches over to the appropriate operation.

During the DR mode, [**DR**] indicator on the indoor unit will blink.

Blinking pattern and the intervals are as follows:

Operation mode	Indicator lamp blinking pattern
Auto/Cooling/Dry/Fan	▶ On → Blinks (2 times) ◀

When the DR mode finishes, the air conditioner returns to the operation set before entering the DR mode.

■ Details on Demand Response mode

DR mode	Description of operation in this mode
DR mode 1	Compressor off.
DR mode 2	Electrical energy consumption in 30 minutes: 50% or less (compared with rated energy consumption)
DR mode 3	Electrical energy consumption in 30 minutes: 75% or less (compared with rated energy consumption)

NOTES:

- During the DR mode, the cooling performance may be reduced.
- During the DR mode, only the following operations are valid.
 - Turning off the operation by \odot/I
 - Off timer operation
- The Powerful operation is performed within the operable range of the DR mode.
- During the DR mode, the Filter sign will not display.
- Timer setting error indicator will be prioritized over the DR mode indicator.

If you have operational issues:

- (1) Contact your electricity supplier to check whether they are activating the DR mode.
- (2) Is the air conditioner under the Demand controlling?

Yes	Contact your electricity supplier.
No	<ul style="list-style-type: none"> • Contact Fujitsu General (AUST.) PTY LIMITED. (Refer to your warranty card.) or • Visit our website (www.fujitsugeneral.com.au).

8. OTHER OPERATION

8.1. Powerful operation

In the Powerful operation, the air conditioner will operate at maximum power and strong airflow to cool down or warm up the room quickly.

\odot Press **POWERFUL** to activate/deactivate the Powerful operation.

When activated, the indoor unit will emit 2 short beeps.
When deactivated, the indoor unit will emit 1 short beep.

The Powerful operation will be turned off automatically in the following situations:

- The Powerful operation runs for a certain amount of time and the room temperature reaches the set temperature in the Cooling or Dry mode.
- 20 minutes after the Powerful operation has started.

NOTES:

- The airflow direction and the fan speed are controlled automatically.
- The Powerful operation cannot be performed simultaneously with Economy operation.
- If the wired remote controller (optional) is connected, this function is restricted.

9. SETTINGS ON INSTALLATION

9.1. Remote controller custom code setting

By setting custom code of indoor unit and remote controller, you can specify the air conditioner which the remote controller controls.

When two or more air conditioners are in the room and you wish to operate them separately, set the custom code (4 selections possible).

NOTE: If custom codes are different between the indoor unit and the remote controller, the indoor unit cannot receive a signal from the remote controller.

How to set the remote controller custom code

1. Press \odot/I until the indicators on the remote controller turn off.
2. Press down **MODE** for more than 5 seconds.
The current custom code will be displayed (initially set to A).
3. Press **TEMP/SELECT** (\wedge/\vee) to change the custom code between
A (a) \leftrightarrow B (b) \leftrightarrow C (c/l) \leftrightarrow D (d).
* Match the custom code on the display to the air conditioner custom code.
4. Press **MODE** again.
The custom code will be set.
The display will return to the original display.

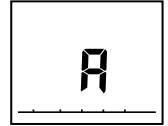

- To change the air conditioner custom code, contact authorized service personnel (initially set to A).
- If you do not press any buttons for 30 seconds after the custom code is displayed, the displayed custom code is set and the display returns to the original display.
- Depending on the remote controller, the custom code may return to A when replacing the batteries. In this case, reset the custom code as necessary. If you do not know the air conditioner custom code, try each code until you find the code which operates the air conditioner.



10. CLEANING AND CARE

! CAUTION

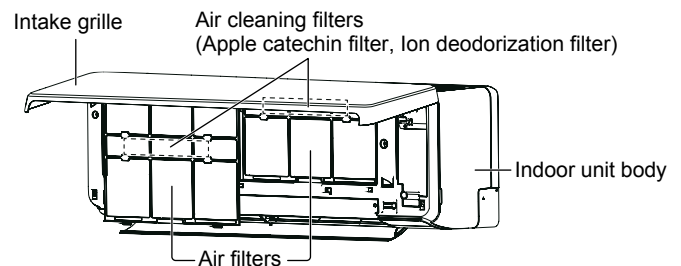
- Before cleaning this product, be sure to turn it off and disconnect all the power supply.
- Before starting operation, make sure that the intake grille has been shut completely. Incomplete closing of the intake grille might have an effect on the proper working or performance of the air conditioner.
- If the filter cleaning involves high-place work, consult the authorized service personnel.
- Do not touch the aluminum fins of heat exchanger built-in the indoor unit to avoid personal injury when you maintain the unit.
- Do not expose the indoor unit to liquid insecticides or hair sprays.
- Do not stand on slippery, uneven or unstable surfaces when you maintain the unit.



The frequency of the cleaning is as shown in the following table.

What to do		Frequency
Indoor unit body	Cleaning	When you notice
Air filter	Cleaning	Every 2 weeks
Apple-catechin filter (UTR-FA16)  (White)	Replacing	Every 3 months
Ion deodorization filter (UTR-FA16-2)  (Light blue)	Cleaning	Every 3 months
	Replacing	Every 3 years

* The air cleaning filters are sold separately. When you replace them, contact the store of purchase.

Cleaning indoor unit body

NOTES:

- Do not use water hotter than 40°C.
- Do not use scouring cleanser, volatile solvents such as benzene or thinner.

1. Wipe the indoor unit body gently with a soft cloth moisten with warm water.
2. Wipe the indoor unit body gently with a dry and soft cloth.

Cleaning air filter

1. Open the intake grille.

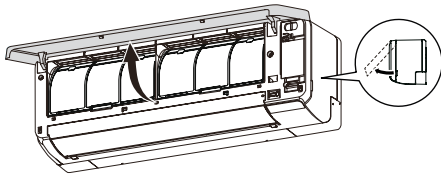

2. Remove the air filters.

Lift up the air filters' handle, disconnect the two lower tabs, and pull out.

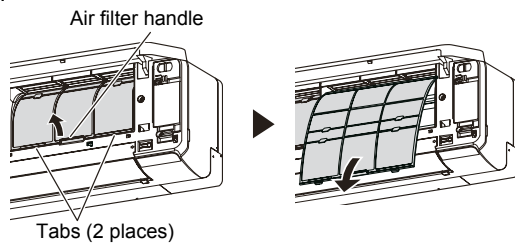

3. Remove the dust in either of the following ways.

- Cleaning with vacuum cleaner.
- Washing with mild detergent and warm water. After washing, dry the air filters thoroughly in shade.

4. Replace the air filters.

Align the sides of the air filter with the panel, and push in fully. Make sure to the two lower tabs are returned to their holes in the indoor unit properly.

5. Close the intake grille.

Press 4 places on the intake grille to close it completely.

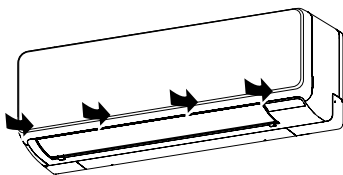

NOTE: If dirt accumulates on the air filter, airflow will be reduced, operating efficiency will lower, and the noise will increase.

Cleaning Ion deodorization filter and Replacing Apple-catechin filter

1. Remove the air filters. Refer to steps 1 ~ 2 of "Cleaning air filter".
2. Remove the air cleaning filters from the air cleaning filter holders.

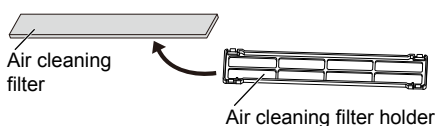

3. Flush the Ion deodorization filter with high-pressure hot water until the surface of the filter is covered with water.

4. Wash the Ion deodorization filter with diluent neutral detergent.

Do not ream or rub. Otherwise, the deodorizing effect may decrease.

5. Rinse the Ion deodorization filter with water flow.

6. Dry the Ion deodorization filter in the shade.

7. Set the new or washed air cleaning filters into the air cleaning filter holders.

NOTE: Use the Apple-catechin filter as soon as possible after opening the package. The air cleaning effect decreases when the filters are left in the opened package.

8. Install the air cleaning filter holders to the air filters.

Engage the 4 hooks at the rear of the air cleaning filter holder with the latch at both ends of the air filter.

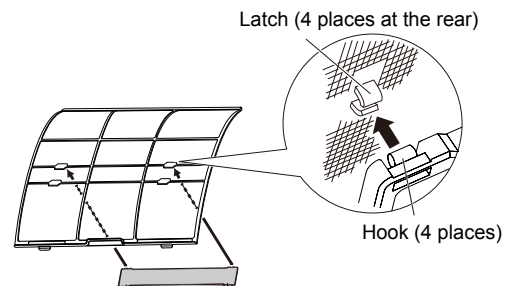

NOTE: Take care that the air cleaning filter does not project beyond the holder.

9. Replace the air filters and close the intake grille. Refer to steps 4 ~ 5 of "Cleaning air filter".

Replacing Ion deodorization filter

1. Remove the air filters. Refer to steps 1 ~ 2 of "Cleaning air filter".
2. Remove the Ion deodorization filter from the air cleaning filter holder.
3. Install the new Ion deodorizing filter.

Removing and installing intake grille

■ Removing intake grille

1. Open the intake grille.
2. While pressing the left and right mounting shafts outward gently, pull the intake grille.

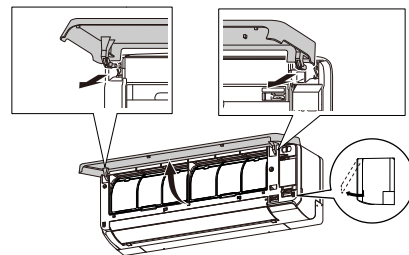

■ Installing intake grille

1. While holding the intake grille horizontal, set the left and right mounting shafts into the pillow blocks at the top of the front panel. Insert the shaft until it snaps to latch each shaft properly.
2. Close the intake grille.
3. Press 4 places on the intake grille to close it completely.

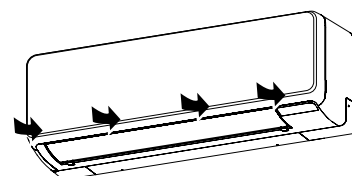

After extended non-use of the unit

If you have shut down the indoor unit for 1 month or more, perform the Fan mode operation for half a day to dry the internal parts thoroughly before the normal operation.

Additional inspection

After long period of use, accumulated dust inside the indoor unit may reduce the performance even if you have maintained the unit properly. In such a case, a product inspection is recommended.

For more information, consult authorized service personnel.

Filter indicator reset (Special setting)

This function can be used if set correctly during installation. Consult authorized service personnel in order to use this function.

☞ Clean the air filter when the indicator lamp shows the following:

Indicator lamp	Blinking pattern
	Blinks 3 times, at intervals of 21 seconds

After cleaning, reset the filter indicator by pushing  on the indoor unit for 2 seconds or less. (Refer to page 3.)

11. GENERAL INFORMATION

■ Auto-restart function

In event of power interruption such as a blackout, the air conditioner stops once. But it restarts automatically and performs previous operation when the power supply is resumed.

If any power interruption occurs after the timer is set, counting down of the timer will be reset.

After the power supply is resumed, [] indicator on the indoor unit blinks to notify you that there has been a timer fault. In such a case, reset the clock and timer settings.

■ Malfunctions caused by other electrical devices

Use of other electrical appliances such as an electric shaver or nearby use of a wireless radio transmitter may cause the malfunction of the air conditioner.

If you encounter such a malfunction, turn off the circuit breaker once. Then turn it on again, and resume operation by using the remote controller.

■ Temperature and humidity range

Permissible ranges of temperature and humidity are as follows:

Cooling/Dry mode	Outdoor temperature	[°C]	10 to 50 ^{*1)}
	Indoor temperature	[°C]	18 to 32
	Indoor humidity	[%]	80 or less ^{*2)}

*1) Suction temperature of the outdoor unit.

*2) If the air conditioner is used continuously for many hours, water may condense on the surface and drip.

- If the unit is operated under the conditions except the permissible temperature range, the air conditioner operation may stop because of the automatic protection circuit working.
- Depending on the operating conditions, the heat exchanger may freeze, causing water leakage or other malfunction (in the Cooling or Dry mode).

■ Other information



- Do not use the air conditioner for any purpose other than room cooling/dry or fan.

12. OPTIONAL PARTS

12.1. Wired remote controller

The optional wired remote controller can be used.

You can use wired and wireless remote controller together.

However, some functions of the wireless remote controller are restricted. If you set the restricted functions, beeping sound will be heard, [], [], and [] indicators on the indoor unit will blink.

<Restricted functions for wireless remote controller>

When using together with wired remote controller (2-wire)

- Powerful operation

Group control

One remote controller can control up to 16 air conditioners. All of the air conditioners will be operated with the same settings.

13. TROUBLESHOOTING

WARNING

 In the following events, immediately stop operation of the air conditioner, and disconnect all the power supply by turning off the electrical breaker or disconnecting the power plug. Then consult your dealer or authorized service personnel.

As long as the unit is connected to the power supply, it is not insulated from the power supply even if the unit is turned off.

- Unit smells of something burning or emits smoke
- Water leaks from the unit

Does not operate at all.

- Has there been a power outage?
In this case, the unit restarts automatically after the power supply is resumed. (Refer to **page 9**.)
- Has the circuit breaker been turned off?
⇒ Turn on the circuit breaker.
- Has a fuse blown out or the circuit breaker been tripped?
⇒ Replace the fuse or reset the circuit breaker.
- Is the timer operating?
⇒ To check or deactivate the timer setting, refer to **page 5**.

Poor cooling performance.

- Is the unit operating under the conditions except the permissible temperature range?
In this case, the air conditioner may stop because of the automatic protection circuit working.
- Do you have an arrangement with your electric company for Demand Response?
In this case, the air conditioning performance may become lower or the operation may stop. (Refer to **page 6**.)
- Is the air filter dirty?
⇒ Clean the air filter. (Refer to **page 7**.)
- Is the intake grille or outlet port of indoor unit blocked?
⇒ Remove the obstructions.
- Is the room temperature adjusted appropriately?
⇒ To change the temperature setting, refer to **page 5**.
- Is a window or door left opened?
⇒ Close the window or the door.
- Is the fan speed set to Quiet?
⇒ To change the fan speed, refer to **page 5**.
- <In the Cooling mode> Is direct or strong sunlight shining into the room?
⇒ Close the curtains.
- <In the Cooling mode> Are there other heating apparatus or computers operating, or too many people in the room?
⇒ Turn the heating apparatus or computers off, or set the temperature lower. (Refer to **page 5**.)

Humidity does not drop during the Dry operation.	
<input type="checkbox"/>	You cannot set the target humidity in the Dry mode. If you feel high humidity, set the temperature lower.
Airflow is weak or stops.	
<input type="checkbox"/>	Is the fan speed set to Quiet? ⇒ To change the fan speed, refer to page 5 .
<input type="checkbox"/>	Has the Fan Control for Energy Saving set? In this case, the indoor unit fan may stop temporarily while the Cooling operation. ⇒ To cancel the Fan control for energy saving, refer to page 6 .
<input type="checkbox"/>	<In the Dry mode> The indoor unit operates at low fan speed to adjust the room humidity, and may stop from time to time.
<input type="checkbox"/>	<In the Auto mode> While the monitoring operation, the fan rotates at very low speed.
Noise is heard.	
<input type="checkbox"/>	Is the unit operating, or immediate after stopping operation? In this case, refrigerant flowing sound may be heard. It may be particularly noticeable for 2-3 minutes after starting operation.
<input type="checkbox"/>	Do you hear a slight squeaking sound during the operation? This sound is produced by the minute expansion and contraction of the front panel caused by temperature change.
Smell coming from the unit.	
<input type="checkbox"/>	The air conditioner may absorb various smells generated from interior textile, furniture, or cigarette smoke. These smells may be emitted during the operation.
Mist or steam is emitted from the unit.	
<input type="checkbox"/>	<In the Cooling or Dry mode> A thin mist may be generated by condensation formed with sudden cooling process.
The unit operates differently from the remote controller setting.	
<input type="checkbox"/>	Do you have an arrangement with your electric company for Demand Response? In this case, the air conditioning performance may become lower or the operation may stop. (Refer to page 6 .)
<input type="checkbox"/>	Are the batteries in the remote controller exhausted? ⇒ Replace the batteries.
Operation is delayed after restart.	
<input type="checkbox"/>	Has the power supply turned from Off to On suddenly? In this case, the compressor will not operate for about 3 minutes to prevent a blowout of the fuse.

Immediately stop operation and turn off the electrical breaker in following cases. Then consult authorized service personnel.

- The problem persists even if you perform these checks or diagnostics.
- On the indoor unit, [] and [⏰] blink while [⏰] is blinking fast.

State of indicator lamps

Lighting pattern: ○ Off, ● On, ● Blinking, — Any state

State	Causes and solutions	See page
(3 times)	Filter indicator ⇒ Clean the air filter and reset the filter sign.	9
(Twice)	Demand response operation	6
(Fast)	Error code display ⇒ Check the error code and consult authorized service personnel.	10

	Timer setting error because of Auto restart ⇒ Reset the clock and timer settings.	9
	Test run operation (for authorized personnel only) ⇒ Press ⏻ to quit the test run.	4
	Restricted function	9

Manual Auto operation and Filter indicator reset

You can operate the air conditioner with on the indoor unit.

Status	Length of pressing down	Mode or operation
In operation	More than 3 seconds	Stop
Stopping	2 seconds or less	Filter indicator reset
	More than 3 seconds and less than 10 seconds	Auto
	More than 10 seconds (Only for servicing.)*	Forced cooling

* To stop the forced cooling, press this button or **⏻** on the remote controller.

Service check

If [] and [⏰] blink while [⏰] is blinking fast on the indoor unit, check the error code. The error code is 2-digit numbers or characters.

- Press [SERVICE CHECK]

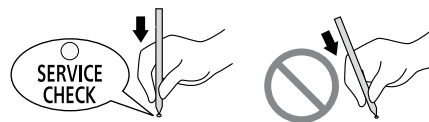

The remote controller enters to the Service check mode and "■■" will appear on the remote controller display.

- Press TEMP/SELECT () to change the shown error code. The indoor unit emits 1 short beep each time the error code changes. When the corresponding error code is shown, the indoor unit emits multiple beeps and all the indicator lamps on the indoor unit blink.

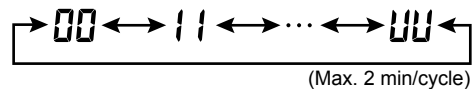

The characters used for error code					
	A		C		F
	J		P		U

To finish the Service check mode, press **⏻**. The remote controller returns to the original display. Tell the error code to authorized service personnel when consulting them. If the indoor unit emits multiple beeps at "00", no error is detected.

FUJITSU GENERAL LIMITED

3-3-17, Suenaga, Takatsu-ku, Kawasaki 213-8502, Japan