

OPERATION MANUAL

AIR CONDITIONER

Cassette type

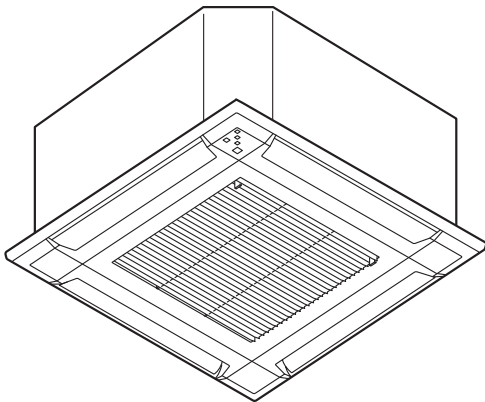

- AUTH09KVLA**
- AUTH12KVLA**
- AUTH18KVLA**

MODEL: **AUTH24KVLA**

* Check the model name.
(Refer to the rating label.)

- Before using this product, read these instructions thoroughly and keep this manual for future reference.
- The warranty card is included with the outdoor unit. It is also available on our website.
(www.fujitsugeneral.com.au)



Contents

1. SAFETY PRECAUTIONS.....	1
2. PREPARATION.....	3
3. NAME OF PARTS.....	3
4. BASIC OPERATIONS.....	3
5. AIRFLOW SETTINGS.....	4
5.1. Fan speed setting.....	4
5.2. Airflow direction setting.....	4
6. TIMER OPERATIONS.....	4
6.1. On timer or Off timer.....	4
6.2. Program timer.....	4
6.3. Sleep timer.....	4
7. ENERGY SAVING OPERATIONS.....	4
7.1. Economy operation.....	4
7.2. Fan control for energy saving.....	4
7.3. Demand Response.....	5
8. OTHER OPERATIONS.....	5
8.1. 10 °C Heat operation.....	5
9. CLEANING AND CARE.....	5
10. GENERAL INFORMATION.....	6
11. OPTIONAL PARTS.....	6
11.1. Remote control.....	6
11.2. Multiple remote controller.....	6
11.3. Group control.....	6
11.4. Multi-split type air conditioner.....	7
12. TROUBLESHOOTING.....	7

1. SAFETY PRECAUTIONS

To prevent personal injury or property damage, read this section carefully before you use this product, and be sure to comply with the following safety precautions.

Incorrect operation due to failure to follow the instructions may cause harm or damage, the seriousness of which is classified as follows:

WARNING

This mark warns of death or serious injury.

CAUTION

This mark warns of injury or damage to property.

This mark denotes an action that is PROHIBITED.





This mark denotes an action that is COMPULSORY.



FUJITSU GENERAL LIMITED







PART No. 9383813351-01

Explanation of symbols displayed on the indoor unit or outdoor unit.

	WARNING This symbol shows that this product uses a low burning velocity material. If the refrigerant is leaked and exposed to an external ignition source, there is a risk of fire.
	CAUTION This symbol shows that the operation manual should be read carefully.
	CAUTION This symbol shows that a service personnel should be handling this equipment with reference to the installation manual.
	CAUTION This symbol shows that information is available such as the operation manual or installation manual.

 WARNING	
	<ul style="list-style-type: none"> When installing this product to an unventilated area, pay attention to prevent fire and explosion caused by the stagnated gas in case of refrigerant leakage. (For products which contain more than 1.842 kg refrigerant.) This product contains no user-serviceable parts. Always consult authorized service personnel for repairing, installation, and relocation of this product. Improper installation or handling will cause leakage, electric shock, or fire. In the event of a malfunction such as burning smell, immediately stop operation of the air conditioner, and disconnect all the power supply by turning off the electrical breaker or disconnecting the power plug. Then consult authorized service personnel. Take care not to damage the power supply cable. If it is damaged, it should be replaced only by the authorized service personnel in order to avoid a hazard. If a refrigerant leakage is suspected, all naked flames shall be removed or extinguished, and consult authorized service personnel. In the event of a thunder storm or any prior sign of a lightning strike, turn off the air conditioner via the remote controller, and refrain from touching the product or the power source to prevent any electrical hazards. This product shall be stored in a room without continuously operating ignition sources (for example: open flames, an operating gas appliance or an operating electric heater). Be aware that refrigerants may not contain an odour. This product shall be stored so as to prevent mechanical damage from occurring. This product is not intended for use by persons (including children) with reduced physical, sensory or mental capabilities, or lack of experience and knowledge, unless they have been given supervision or instruction concerning use of this product by a person responsible for their safety. Children should be supervised to ensure that they do not play with this product. Dispose of the packing materials safely. Tear and dispose of the plastic packing bags so that children cannot play with them. There is the danger of suffocation if children play with the original plastic bags.

 WARNING	
	<ul style="list-style-type: none"> Do not move this product by holding the indoor unit pipes. (The stress applied to the pipe joints may cause the flammable gas to leak during operation). Do not start or stop the operation of this product by turning on or off the circuit breaker. Do not use flammable gases near this product. Do not expose yourself directly to the cooling airflow for many hours. Do not insert your fingers or any other objects into the air inlet or the air outlet Do not operate with wet hands. Do not use means to accelerate the defrosting process or to clean this product, other than those recommended in this manual. Do not pierce or burn.

 CAUTION	
	<ul style="list-style-type: none"> Provide occasional ventilation during use. Before cleaning this product, be sure to turn it off and disconnect all the power supply. Always operate this product with air filters installed. Ensure that any electronic equipment is at least 1 m (40 in) away from this product. Disconnect all the power supply when not using this product for extended periods. After a long period of use, ensure to get the mounting of the indoor unit checked to prevent this product from falling down. The airflow direction and the room temperature should be carefully considered when you use this product in a room with infants, children, elderly or sick persons. Keep the surroundings of the outdoor unit clean and tidy, and do not place items around it. Any objects blocking or entering from the outlet ports may cause product malfunction.
	<ul style="list-style-type: none"> Do not direct the airflow at fireplaces or heating apparatus. Do not block or cover the air inlet and the air outlet. Do not apply any heavy pressure to radiator fins. Do not climb on, place objects on, or hang objects from this product. Do not place any other electrical products or household belongings under this product. Dripping condensation from this product might get them wet, and may cause damage or malfunction of your property. Do not expose this product directly to water. Do not use this product for preservation of food, plants, animals, precision equipment, art work, or other objects. This may cause quality deterioration of those items. Do not expose animals or plants to the direct airflow. Do not drink the drainage from the air conditioner. Do not touch the aluminum fins of heat exchanger built-in this product to avoid personal injury when you maintain the unit. Do not stand on unstable steps when operating or cleaning this product. It may overturn and can cause injury.

This product contains fluorinated greenhouse gases.

2. PREPARATION

Check that the following items are included.

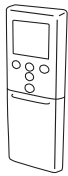

Remote controller



Remote controller holder



Self-tapping screws



Batteries

3. NAME OF PARTS

For detailed instructions on how to operate, refer to the operation manual of the remote controller.

When you use the optional remote controller, the operation procedure may differ.

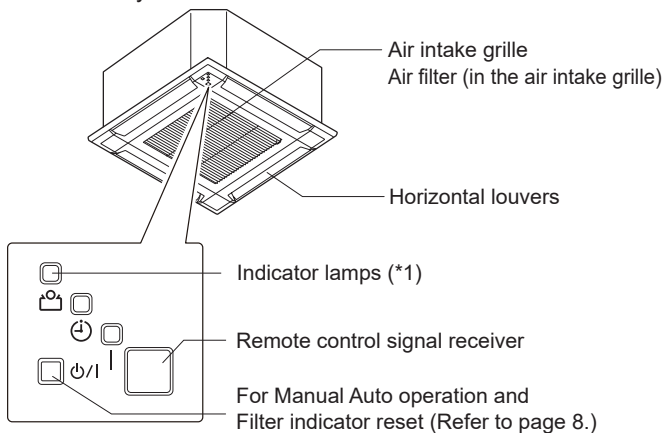

*1: Indicator lamps light in the following conditions.

	Name	Color	Operation or condition
	Operation	Green	Normal operation
🕒	Timer	Orange	Timer operation (*2)
🏠	Economy	Green	Economy operation 10 °C Heat operation (*2)

*2: The lamp lights only when the operation is set from the wireless remote controller.

4. BASIC OPERATIONS

NOTE: For detailed instructions on how to operate, refer to the operation manual of the remote controller.

The operation mode and the temperature setting range are shown in the following table.

Operation mode	Temperature setting range
Auto /Cooling/Dry	18.0 - 30.0 °C
Fan	You cannot set the temperature.
Heating	16.0 - 30.0 °C

■ Auto mode

The air conditioner selects the appropriate operation mode (Cooling or Heating) according to your room's present temperature.

Room temperature	Operation
Higher than the setting temperature	Cooling
Close to the setting temperature	Monitor operation
Lower than the setting temperature	Heating

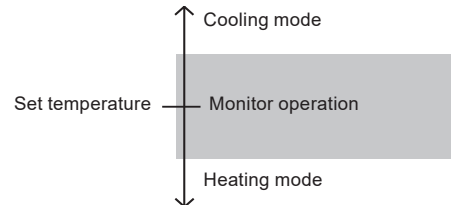

When Auto mode is first selected, the fan will operate at a low speed for about a few minutes, during which time the indoor unit detects the room conditions and selects the operation mode.

When the air conditioner has adjusted your room's temperature to near the thermostat setting, it will begin monitor operation.

In the monitor operation mode, the fan will operate at a low speed. If the room temperature subsequently changes, the air conditioner will once again select the appropriate operation (Heating, Cooling) to adjust the temperature to the value set in the thermostat.

If the mode automatically selected by the unit is not what you wish, select one of the mode operations (Heating, Cooling).

■ Cooling mode

Use to cool your room.

NOTE: Set the temperature lower than the current room temperature.

■ Dry mode

Use for gently cooling while dehumidifying your room.

NOTES:

- You cannot heat the room.
- Set the temperature lower than the current room temperature, otherwise, the operation will not operate.
- The unit will operate at low speed in order to adjust room humidity. The indoor unit's fan may stop from time to time. Also, the fan may operate at very low speed when adjusting room humidity.
- The fan speed cannot be changed manually.

■ Fan mode

Use to circulate the air throughout your room.

NOTE: You cannot set the temperature.

■ Heating mode

Use to warm your room.

NOTES:

- Set the temperature higher than the current room temperature, otherwise, the operation will not operate.
- At the beginning of the operation, the indoor unit fan rotates at very low speed for 3-5 minutes to warm the internal indoor unit. After the period, the indoor unit fan will switch to the selected fan speed.
- When the room temperature is very low, frost may form on the outdoor unit, and its performance may be reduced. In order to remove such frost, the unit will automatically enter the defrost cycle from time to time. During Automatic defrosting operation, the Heating operation will be interrupted.
- After the start of Heating operation, it takes sometime before the room gets warmer.

5. AIRFLOW SETTINGS

NOTE: For detailed instructions on how to operate, refer to the operation manual of the remote controller.

5.1. Fan speed setting

Fan speed	Description
Auto	The fan speed is automatically adjusted according to the operation mode. Cooling : As the room temperature approaches the set temperature, the fan speed becomes lower. Heating : The fan will operate at a very low speed when the temperature of the air issued from the indoor unit is low. Fan : The fan runs at Med speed.
High	The indoor unit fan rotates at a high speed.
Med	The indoor unit fan rotates at a middle speed.
Low	The indoor unit fan rotates at a low speed.
Quiet	The indoor unit fan rotates at the lowest speed for Quiet operation. • The Quiet operation cannot be used during the Dry mode. (It includes the Dry mode selected during the Auto mode operation.) • During the Quiet operation, heating and cooling performance will be reduced somewhat. If the room does not warm up/ cool down when using the Quiet operation, adjust the indoor unit's fan speed.

The fan will operate at a very low setting during the monitor operation and at the start of the heating mode.

5.2. Airflow direction setting

You can set the following items.

- Up/down airflow direction setting
- Swing operation setting (up/down)

NOTE : The Swing operation may stop temporarily when the indoor unit fan is rotating at very low speed or is stopped.

■ Up/down airflow direction

Comfortable airflow spread to every corner of the room by the wide up/down airflow.

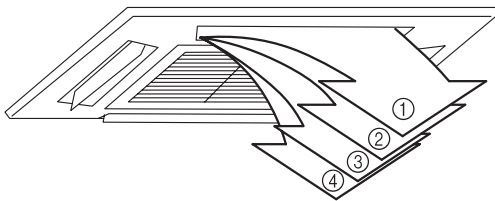

Change manually	1	↔	2	↔	3	↔	4
Swing operation	1		↔		3		4

NOTES:

- Do not adjust the louvers by hand. It could result in improper operation. In this case, stop operation and restart. The louvers should begin to operate properly again.
- Even if the airflow direction is set, it may operate at a different position in the following operation.
 - at the start of the Heating operation (position 1)
 - during the Automatic defrosting operation
 - at the start of the Auto mode operation (position 1 or 4)
- When used in a room with infants, children, elderly or sick persons, the air direction and room temperature should be considered carefully when making settings.

6. TIMER OPERATIONS

6.1. On timer or Off timer

The On timer starts the operation at your desired time.
 The Off timer stops the operation at your desired time.

6.2. Program timer

The Program timer operates as the combination of the On timer and Off timer.

You can set the Program timer only within a span of 24 hours.

6.3. Sleep timer

The Sleep timer supports your comfortable sleep by moderating the air conditioner operation gradually.

The time setting of the Sleep timer changes as follows:

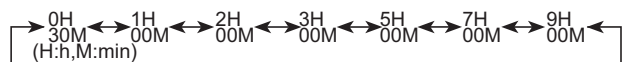

During the Sleep timer operation, the setting temperature changes as the following figure.

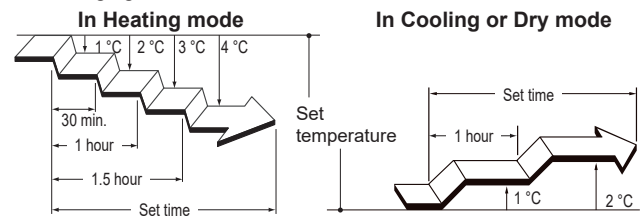

After the set time has elapsed, the air conditioner operation turns off.

7. ENERGY SAVING OPERATIONS

7.1. Economy operation

It saves more electricity than other operation modes by changing the set temperature to a moderate setting.

Operation mode	Room temperature
Cooling/Dry	Few degrees higher than the set temperature
Heating	Few degrees lower than the set temperature

During the Economy operation, [E] indicator on the indoor unit will turn on.

NOTES:

- In the Cooling, Heating, or Dry mode, the maximum output of this operation is approximately 70 % of usual operation. If the room is not cooled or heated well during the Economy operation, select normal operation.
- This operation cannot be performed during the temperature monitoring by the Auto mode.
- In the multi-split type air conditioner, the Economy operation mode is only available for the set indoor unit.

7.2. Fan control for energy saving

In the Cooling or Dry operation, when the room temperature reaches the set temperature, the indoor unit fan rotates intermittently to save power.

This function is deactivated at the time of purchase.

To change the setting, refer to the operation manual of the remote controller.

Even if the setting is changed, if the fan speed is set to Auto in Cooling or Dry mode, this function still works to suppress the diffusion of circulated indoor humidity.

7.3. Demand Response

This product is designed to be compatible with Air Conditioning Demand Response program.

To utilize the function, you need a separate arrangement with your electricity supplier. Check availability in the place of use.

When your electricity supplier activates one of the following 3 Demand Response (DR) modes, the air conditioner switches over to the appropriate operation.

During the DR mode, [] indicator on the indoor unit will blink.

Blinking pattern and the intervals are as follows:

Operation mode	Indicator lamp blinking pattern
Auto/Cooling/Heating/Dry/Fan	▶ On → Blinks (2 times) ◀
10°C Heat operation	▶ Off → Blinks (2 times) ◀

When the DR mode finishes, the air conditioner returns to the operation set before entering the DR mode.

Details on Demand Response mode

DR mode	Description of operation in this mode
DR mode 1	Compressor off.
DR mode 2	electrical energy consumption in 30 minutes: 50 % or less (compared with rated energy consumption)
DR mode 3	electrical energy consumption in 30 minutes: 75 % or less (compared with rated energy consumption)

NOTES:

- During the DR mode, the cooling or heating performance may be reduced.
- During the DR mode, only the following operations are valid.
 - Turning off the operation by the remote controller
 - Off timer operation
- During the DR mode, the Filter sign will not display.
- Timer setting error indicator will be prioritized over the DR mode indicator.

If you have operational issues:

- (1) Contact your electricity supplier to check whether they are activating the DR mode.
- (2) Is the air conditioner under the Demand controlling?

Yes	Contact your electricity supplier.
No	<ul style="list-style-type: none"> • Contact Fujitsu General (AUST.) PTY LIMITED. (Refer to your warranty card.) or • Visit our website (www.fujitsugeneral.com.au).

8. OTHER OPERATIONS

8.1. 10 °C Heat operation

10 °C Heat operation maintains the room temperature at 10 °C so as to prevent the room temperature to drop too low.

- When activated, [] indicator on the indoor unit will turn on.
- When deactivated, [] indicator will turn off.

NOTES:

- During the 10 °C Heat operation, only the up/down airflow setting is valid.
- When the room temperature is warm enough, This operation will not be performed.
- In the multi-split type air conditioner, the room temperature will rise higher than 10 °C if the other indoor units operate at Heating mode. When using the 10 °C Heat operation, we recommend that setting all indoor units at 10 °C Heat operation.

9. CLEANING AND CARE

CAUTION

- Before cleaning the indoor unit, be sure to turn it off and disconnect all the power supply.
- The fan operates at high speed inside the unit, and could result in personal injury.
- Be careful not to drop the intake grille.
- If the filter cleaning involves high-place work, consult the professional technical service personnel.
- Do not expose the indoor unit to liquid insecticides or hair sprays.
- Do not stand on slippery, uneven or unstable surfaces when you maintain the unit.

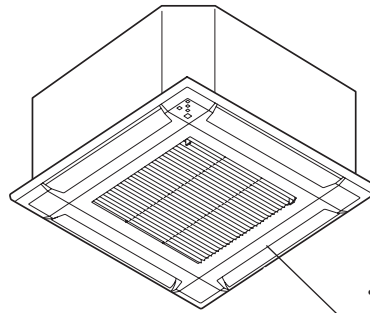

- Air intake grille
- Air filter (in the air intake grille)

The indoor unit's intake grille can be removed for easy cleaning and maintenance.

When cleaning the unit, do not use water hotter than 40°C, harsh abrasive cleansers, or volatile agents like benzene or thinner.

Cleaning air filter

- 1 Push the intake grille's hooks inward towards the center of the unit to open the intake grille.

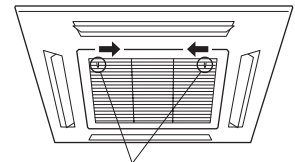

Grille hook

- 2 Pull out the filter from the intake grille.

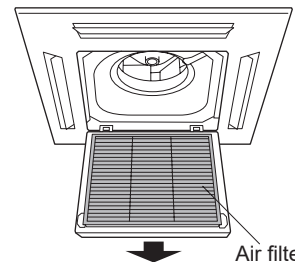

Air filter

- 3 Remove the dust in either of the following ways.
 - Cleaning with vacuum cleaner.
 - Washing with mild detergent and warm water. After washing, dry the air filters thoroughly in shade.

- 4 Re-attach the air filters to the intake grille.
 - (1) Replace the air filter into its holder.
 - (2) Make sure that the air filter makes contact with the filter stopper when it is replaced into its holder.

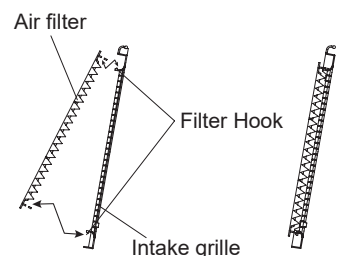

- 5** Close the intake grille and push the intake grille's hooks outward.

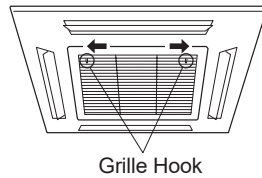

NOTE: If dirt accumulates on the air filter, airflow will be reduced, operating efficiency will lower, and the noise will increase.

After extended non-use of the unit

If you do not use this product for 1 month or more, perform the Fan mode operation for half a day to dry the internal parts thoroughly before you perform normal operation.

Additional inspection

After long period of use, accumulated dust inside the indoor unit may reduce the product performance even if you have maintained the unit with instructed daily care or cleaning procedures written in this manual. In such a case, a product inspection is recommended.

For more information, consult authorized service personnel.

Filter indicator reset (Special setting)

This function can be used if set correctly during installation. Consult authorized service personnel in order to use this function.

☞ Clean the air filter when the indicator lamp show the following:

Indicator lamp	Blinking pattern
	Blinks 3 times, at intervals of 21 seconds

After cleaning, reset the filter indicator by pushing on the indoor unit for 2 seconds or less.

10. GENERAL INFORMATION

Inverter

On start-up, the air conditioner will operate at maximum capacity to bring the room quickly down to desired temperature.

Once the room temperature reaches to the set temperature, the air conditioner will reduce its capacity and energy usage to the minimum capacity and input ratings.

Heating performance

This air conditioner operates on the heat-pump principle, absorbing heat from air outdoors and transferring that heat to the indoor unit. As a result, the operating performance is reduced as outdoor air temperature drops.

If you feel that the heating performance is insufficient, we recommend you to use this air conditioner in conjunction with other kinds of heating appliance.

Consult with your installation technician to ensure the unit is correctly sized for the room space required.

Heat-pump air conditioners heat your entire room by recirculating air throughout the room, with the result that some time may be required after first starting the air conditioner until the room is heated.

Automatic defrosting operation

When outdoor temperature is very low with high humidity, frost may form on the outdoor unit during the heating operation, and it could reduce the operating performance of the product.

For frost protection, an automatic defrosting function is equipped in this air conditioner.

If frost forms, the air conditioner will temporarily stop, and defrost circuit will operate briefly (maximum of 15 minutes.)

[] indicator on the indoor unit blinks during this operation.

If frost forms on the outdoor unit after the Heating operation, the outdoor unit will stop automatically after it operates for a few minutes. Then the Automatic defrosting operation starts.

Auto restart function

In event of power interruption such as a blackout, the air conditioner stops once. But it restarts automatically and performs previous operation when the power supply is resumed.

If any power interruption occurs after the timer is set, counting down of the timer will be reset.

After the power supply is resumed, [] indicator on the indoor unit blinks to notify you that there has been a timer fault. In such a case, reset the clock and timer settings.

Malfunctions caused by other electrical devices

Use of other electrical appliances such as an electric shaver or nearby use of a wireless radio transmitter may cause the malfunction of the air conditioner.

If you encounter such a malfunction, disconnect the power supply once. Then reconnect it, and resume operation by using the remote controller.

Operable conditions of temperature and humidity

Permissible ranges of temperature and humidity are as follows:

Indoor temperature	Cooling/Dry	[°C]	18 to 32
	Heating	[°C]	16 to 30
Indoor humidity		[%]	80 or less (*1)

*1: If the air conditioner is used continuously for many hours, water may condense on the surface and drip.

- If the unit is operated under the conditions except the permissible temperature range, the air conditioner operation may stop because of the automatic protection circuit working.
- Depending on the operating conditions, the heat exchanger may freeze, causing water leakage or other malfunction. (in the Cooling or Dry mode).

When indoor and outdoor temperatures are high

When both indoor and outdoor temperatures are high during use of the Heating mode, the outdoor unit's fan may stop at times.

Low ambient cooling

When the outdoor temperature drops, the outdoor unit's fans may switch to low speed, or one of the fans may stop intermittently.

Other information

- Do not use the air conditioner for any purpose other than room cooling/dry, room heating or fan.
- During the Heating mode, the top of the indoor unit may become warm, but this is due to the fact that coolant is circulated through the indoor unit even when it is stopped; it is not a malfunction.

11. OPTIONAL PARTS

11.1. Remote control

The optional wired remote controller can be used.

You can use wired and wireless remote controller together.

However, some functions of the wireless remote controller are restricted. Refer to the operation manual of the remote controller for details.

11.2. Multiple remote controller

You can connect two wired remote controllers to one air conditioner. Either remote controller can control the air conditioner.

However, the timer functions cannot be used by the secondary unit.

11.3. Group control

One wired remote controller can control up to 16 air conditioners. All of the air conditioners will be operated with the same settings.

11.4. Multi-split type air conditioner

NOTE: Depending on model, this function cannot be used. For details, consult authorized service personnel.

This indoor unit can be connected to a multi-split type outdoor unit. The multi-split type air conditioner allows multiple indoor units to be operated in multiple locations. The indoor units may be operated simultaneously, in accordance with their respective output.

Simultaneous Use of Multiple Units

- When using a multi-split type air conditioner, the multiple indoor units can be operated simultaneously, but when 2 or more indoor units of the same group are operated simultaneously, the heating and cooling efficiency will be less than when a single indoor unit is used alone. Accordingly, when you wish to use more than 1 indoor unit for cooling at the same time, the use should be concentrated at night and other times when less output is required. In the same way, when multiple units are used simultaneously for heating, it is recommended that they be used in conjunction with other auxiliary space heaters, as required.
- Seasonal and outdoor temperature conditions, the structure of the rooms and the number of persons present may also result in differences of operating efficiency. We recommend that you try various operating patterns in order to confirm the level of heating and cooling output provided by your units, and use the units in the way that best matches your family's lifestyle.
- If you discover that 1 or more units delivers a low level of cooling or heating during simultaneous operation, we recommend that you stop simultaneous operation of the multiple units.
- Operation cannot be done in the following different operating modes.
If the indoor unit is instructed to do an operating mode that it cannot perform, [I] indicator on the indoor unit will blink (1 second on, 1 second off) and the unit will go into the standby mode.
Heating mode and Cooling mode (or Dry mode)
Heating mode and Fan mode
- Operation can be done in the following different operating modes.
Cooling mode and Dry mode
Cooling mode and Fan mode
Dry mode and Fan mode
- The operating mode (Heating mode or Cooling (Dry) mode) of the outdoor unit will be determined by the operating mode of the indoor unit that was operated first. If the indoor unit was started in the Fan mode, the operating mode of the outdoor unit will not be determined.
For example, if indoor unit (A) was started in the Fan mode and then indoor unit (B) was then operated in the Heating mode, indoor unit (A) would temporarily start operation in the Fan mode but when indoor unit (B) started operating in the Heating mode, [I] indicator for indoor unit (A) would begin to blink (1 second on, 1 second off) and it would go into standby mode. Indoor unit (B) would continue to operate in Heating mode.

12. TROUBLESHOOTING



WARNING

! In following events, immediately stop operation of the air conditioner, and disconnect all the power supply by turning off the electrical breaker or disconnecting the power plug. Then consult your dealer or authorized service personnel.

As long as the unit is connected to the power supply, it is not insulated from the power supply even if the unit is turned off.

- Unit smells of something burning or emits smoke
- Water leaks from the unit

Does not operate at all.

- Has there been a power outage?
In this case, the unit restarts automatically after the power supply is resumed. (Refer to **page 6.**)
- Has the circuit breaker been turned off?
⇒ Turn on the circuit breaker.
- Has a fuse blown out or the circuit breaker been tripped?
⇒ Replace the fuse or reset the circuit breaker.
- Is the timer operating?
⇒ To check or deactivate the timer setting, Refer to the operation manual of the remote controller.

Poor cooling or heating performance.

- Is the unit operating under the conditions except the permissible temperature range?
In this case, the air conditioner may stop because of the automatic protection circuit working.
- Do you have an arrangement with your electric company for Demand Response?
In this case, the air conditioning performance may become lower or the operation may stop. (Refer to **page 5.**)
- Is the air filter dirty?
⇒ Clean the air filter. (Refer to **page 5.**)
- Is the intake grille or outlet port of indoor unit blocked?
⇒ Remove the obstructions.
- Is the room temperature adjusted appropriately?
⇒ To change the setting temperature, refer to the operation manual of the remote controller.
- Is a window or door left opened?
⇒ Close the window or the door.
- Is the fan speed set to Quiet?
⇒ To change the fan speed, refer to the operation manual of the remote controller.
- <In the Cooling mode> Is direct or strong sunlight shining into the room?
⇒ Close the curtains.
- <In the Cooling mode> Are there other heating apparatus or computers operating, or too many people in the room?
⇒ Turn the heating apparatus or computers off, or set the temperature lower.

Airflow is weak or stops.

- Is the fan speed set to Quiet?
⇒ To change the fan speed, refer to the operation manual of the remote controller.
- Has the Fan Control for Energy Saving set? In this case, the indoor unit fan may stop temporarily while the Cooling operation.
⇒ To cancel the Fan Control for Energy Saving, refer to the operation manual of the remote controller.
* This function cannot be disabled when the fan speed is set to Auto.
- <In the Heating mode> Have you just started the operation?
In this case, the fan rotates at very low speed temporarily to warm up the internal parts of the unit.
- <In the Heating mode> Is the room temperature higher than the set temperature?
In this case, the outdoor unit stops and the indoor unit fan rotates at very low speed.
- <In the Heating mode> Is the Automatic defrosting operation working? In this case, the indoor unit stops for maximum of 15 minutes. (Refer to **page 6.**)
- <In the Dry mode> The indoor unit operates at low fan speed to adjust the room humidity, and may stop from time to time.
- <In the Auto mode> While the monitoring operation, the fan rotates at very low speed.
- <In multi-split connection> Are multiple units set in different operation mode as shown below?
In this case, the units set afterward will stop and [I] indicator will blink.
• Heating mode and other mode

Airflow direction does not change according to the setting or does not change at all.

- <In the Auto mode> In the Auto mode, the airflow direction is set automatically.
- <In the Heating mode> Have you just started the operation? In this case, the airflow direction keeps the default position for a while.
- <In the Heating mode> During the Automatic defrosting operation, the airflow direction is set automatically.

Humidity does not drop.

- <In the Dry operation> If the setting temperature is high, the humidity may not drop.
⇒ To lower the humidity, lower the setting temperature.

Noise is heard.

- Is the unit operating, or immediate after stopping operation? In this case, refrigerant flowing sound may be heard. It may be particularly noticeable for 2-3 minutes after starting operation.
- Do you hear a slight squeaking sound during the operation? This sound is produced by the minute expansion and contraction of the front panel caused by temperature change.
- <In the Heating mode> Do you hear a sizzling sound? This sound is produced by the Automatic defrosting operation. (Refer to **page 6**.)

Smell coming from the unit.

- The air conditioner may absorb various smells generated from interior textile, furniture, or cigarette smoke. These smells may be emitted during the operation.

Mist or steam is emitted from the unit.

- <In the Cooling or Dry mode> A thin mist may be generated by condensation formed with sudden cooling process.
- <In the Heating mode> Is the Automatic defrosting operation working? In this case, steam may rise from the outdoor unit. (Refer to **page 6**.)

Outdoor unit emits water.

- <In the Heating mode> The outdoor unit may emit water generated by the Automatic defrosting operation. (Refer to **page 6**.)

The unit operates differently from the remote controller setting.

- Do you have an arrangement with your electric company for Demand Response? In this case, the air conditioning performance may become lower or the operation may stop. (Refer to **page 5**.)
- Are the batteries in the remote controller exhausted? ⇒ Replace the batteries.



Operation is delayed after restart.



- Has the power supply turned from off to on suddenly? In this case, the compressor will not operate for about 3 minutes to prevent a blowout of the fuse.
- Has the electrical breaker is turned off then on again? In this case, the protection circuit will operate for about 3 minutes.























Immediately stop operation and turn off the electrical breaker in following cases. Then consult authorized service personnel.

- The problem persists even if you perform these checks or diagnostics.
- Error sign is shown on the wired remote controller display or the indicator lamps on the indoor unit.



State of indicator lamps

Lighting pattern:  Blinking,  Any state (Off or On)

State	Causes and solutions	See page
  	Automatic defrosting operation ⇒ Please wait until finishing the defrosting (maximum of 15 minutes).	6

   (3 times)	Filter indicator ⇒ Clean the air filter and reset the filter sign.	6
   (Twice)	Demand response operation	5
   (Fast)	Error code display ⇒ Consult authorized service personnel.	-
  	Timer setting error because of Auto restart ⇒ Reset the clock and timer settings.	6
  	Test run operation (for authorized personnel only) ⇒ Press   to quit the test run.	-
  	Restricted function	7
   (Slow)	(In multi-split connection) Standby mode ⇒ Check the set operation mode of the indoor units.	7

Manual Auto operation and Filter indicator reset

You can operate the air conditioner with   on the indoor unit.

Status	Length of pressing down	Mode or operation
In operation	More than 3 seconds	Stop
Stopping	2 seconds or less	Filter indicator reset
	More than 3 seconds and less than 10 seconds	Auto (*1)
	More than 10 seconds (Only for servicing. (*2))	Forced cooling

*1: In multi-split connection, the operation mode follows the other indoor units.

*2: To stop the forced cooling, press this button or  on the wireless remote controller.

FUJITSU GENERAL LIMITED

3-3-17, Suenaga, Takatsu-ku, Kawasaki 213-8502, Japan